

# EX-TRACK<sup>®</sup> CNC

## EX-TRACK<sup>®</sup> PORTABLE CNC CUTTING SYSTEM

### Operator Manual



**Revision Date: June 24, 2022**  
**Revision Number: 02.5**  
**Language: English**  
**For Firmware: 3.0.4-1.2.9 – 1.3.2**

**PLEASE, CHECK THE LATEST VERSION OF THE OPERATOR MANUAL ON OUR WEBSITE:**  
[www.ex-track.com](http://www.ex-track.com)

## **Foreword**

Thank you for purchasing the Thermacut® EX-TRACK® CNC Cutting System, the system is available with an oxy fuel cutting torch, optionally a plasma system can be added. The system has been designed and manufactured to deliver: reliability, dimensional accuracy and reproducible profile part cutting. The system is easy to operate and maintain, read this instruction manual before proceeding, be aware, there is a potential for danger upon installation, operating or maintaining the system.

It is the responsibility of the operator/user to ensure the safe use/handling of the system, refer to Thermacut's terms and conditions of sale for specific responsibilities and limitations on liability.

Information in this document is subject to change without notice. The manual is for the convenience and use of the Thermacut® EX-TRACK® CNC Cutting System purchaser, it is not a contract or obligation on the part of Thermacut® The Cutting Company.

## **Safety precautions**

This instruction manual describes the correct, effective and safe use of the system. All personnel involved in the use or maintenance of the system should read this instruction manual thoroughly and familiarize themselves in the correct and safe method of operation. A copy of this instruction manual should be kept with the system at all times for easy reference.

# INDEX

Foreword.....	2
Safety precautions .....	2
<b>1. SAFETY INSTRUCTIONS .....</b>	<b>9</b>
1.1. General system safety precautions .....	12
1.1.1. System safety .....	12
1.1.2. Personal protective equipment .....	12
1.1.3. Safety precautions prior to handling and operation .....	13
1.2. Plasma/oxy fuel gas cutting safety awareness .....	14
1.2.1. Prevention of fire and explosion.....	14
1.2.2. Safe use of gas pressure regulators .....	14
1.2.3. Gas cylinder handling and storage .....	14
1.2.4. Oxy fuel gas hose safety precautions .....	14
1.2.5. Risk of fire .....	15
1.2.6. Risk of burn injury .....	15
1.2.7. Safety in the workplace .....	16
<b>2. LOCATION OF WARNING AND SAFETY LABELS .....</b>	<b>18</b>
<b>3. SPECIFICATION .....</b>	<b>22</b>
3.1. System overview .....	23
3.1.1. Main features .....	23
3.1.2. Range of application.....	23
3.2. System parts description .....	23
3.3. Technical parameters .....	24
3.4. Torch height controller.....	25
3.5. Gas supply.....	25
<b>4. UNPACKING AND ASSEMBLY .....</b>	<b>26</b>
4.1. Packing list.....	27
4.2. System assembly .....	28
4.2.1. Parts check .....	28
4.2.2. Fitting the main unit on to the longitudinal guide rail.....	28
4.2.3. Fitting the transverse guide rail.....	29
4.2.4. Fitting the torch height controller .....	29
4.2.5. Gas supply connection .....	30
4.2.6. Electrical connection .....	30
<b>5. CUTTING PROCESS .....</b>	<b>32</b>
5.1. Prior to operating the system.....	33

5.1.1. Input voltage settings .....	33
5.1.2. EX-TRACK® placement .....	33
5.1.3. Oxy fuel nozzle choice .....	33
5.1.4. Regulated gas supply .....	33
5.1.5. Oxy fuel cut charts.....	33
5.1.6. Pre-ignition check.....	34
5.2. Ignition and flame adjustment - oxy propane cutting .....	34
5.3. Cut quality .....	35
5.4. Preheat time .....	35
5.5. Torch operation.....	35
5.6. Flashback and backfire prevention .....	36
5.6.1. Flashback prevention .....	36
5.6.2. Backfire prevention .....	36
<b>6. SYSTEM OPERATION.....</b>	<b>38</b>
6.1. Oxy fuel cutting (prior to operation) .....	39
6.2. Plasma arc cutting (prior to operation).....	40
<b>7. MAINTENANCE .....</b>	<b>41</b>
7.1. Cleaning the system.....	42
7.2. System lubrication .....	42
7.3. Drive motor adjustment.....	42
7.4. Oxy fuel nozzle maintenance .....	42
<b>8. CIRCUIT DIAGRAM .....</b>	<b>44</b>
8.1. Plasma interface.....	46
<b>9. OPERATION .....</b>	<b>47</b>
9.1. Control panel functions .....	50
9.2. CNC system functions.....	50
9.3. System main menu .....	51
9.3.1. Menu features .....	51
9.3.2. Main function F-key menu.....	52
9.4. Automatic function .....	52
9.4.1. Interfaces and inputs .....	53
9.4.1.1. Speed .....	53
9.4.1.2. Prog, pierce, kerf .....	53
9.4.1.3. Work mode - running status .....	53
9.4.1.4. Input and output signals .....	53
9.4.1.5. System parameters display .....	53
9.4.1.6. System coordinates display .....	54
9.4.1.7. Zoom function [key 1].....	54
9.4.1.8. Return [key 2].....	54

9.4.1.9. Dry run [X] .....	55
9.4.1.10. Speed [Y] .....	55
9.4.2. Auto processing menu [MAIN MENU → F1 (AUTO)] .....	55
9.4.2.1. Pierce point [F1 (SECTION)] .....	55
9.4.2.2. Manual mode [F2 (MANUAL)] .....	55
9.4.2.3. Break point [F3 (BRK)].....	55
9.4.2.4. Preview [F4].....	56
9.4.2.5. Kerf [F5].....	56
9.4.2.6. More [F6].....	56
9.4.2.6.1. Outline [F1].....	57
9.4.2.6.2. Rotate (re-orientation) [F3] .....	57
9.4.2.6.2.1. Re-orientation angle processing .....	57
9.4.2.6.3. Mirror [F4].....	58
9.4.2.6.4. Scale [F5].....	58
9.4.2.6.5. Nest [F6].....	58
9.4.2.6.6. Tapping - bridge function [F7 BREAK] .....	59
9.4.2.7. Return [F7].....	59
9.5. Automatic program mode.....	59
9.5.1. Cutting speed .....	60
9.5.2. Process start point .....	60
9.5.3. Active key functions when running a program.....	60
9.5.4. Active key functions in pause mode .....	61
9.5.5. Select program .....	63
9.5.6. Edge start cutting .....	63
9. 6. Manual mode .....	64
9.6.1. Manually controlled functions .....	64
9.6.1.1. [↑] [↓] [←] [→] [UP] [DOWN] [LEFT] [RIGHT] directional control keys [G]65	65
9.6.1.2. Mode switching [F1] .....	65
9.6.1.3. Step [F2] .....	65
9.6.1.4. More [F3].....	65
9.6.1.4.1. P-START [F3] a P-END [F4] .....	66
9.6.1.4.2. Coordinates settings [F5].....	66
9.6.1.4.3. Origin [F7].....	66
9.6.1.5. Mach-0 [F4] .....	66
9.6.1.6. Rapid [F5].....	66
9.6.1.7. Prog-0 [F6] .....	66
9.6.1.8. Return [F7] .....	66
9.7. Editing function .....	67
9.7.1 Edit function .....	67
9.7.1.1. New [F1].....	67
9.7.1.2. Load [F2] .....	67
9.7.1.3. Save [F3] .....	68
9.7.1.4. Del file [F4].....	68

---

9.7.1.5. Del line [F5].....	68
9.7.1.6. USB [F6].....	68
9.7.1.7. View [F7].....	68
9.8. Setup [F4 PARAMER] .....	68
9.8.1. Process definition - speed.....	68
9.8.2. Speed parameters [F1].....	69
9.8.3. System parameters .....	70
9.8.4. OXY parameters .....	71
9.9. Plasma parameters.....	72
9.9.1. Control parameters .....	73
9.9.2. THC .....	75
9.9.3. Save [F7].....	75
9.9.4. Gallery function .....	76
9.9.5. Graphics library .....	76
9.9.6. Graphics library (shape development).....	76
9.9.7. Shape check.....	76
9.9.7.1. Inside diameter cut [F1] and [F2] Outside diameter cut.....	77
9.9.8. Graphics library (nest function) .....	77
9.10. Program function.....	78
9.10.1. CNC program symbols (G - codes).....	78
9.10.2. File types .....	79
9.10.3. File names .....	79
9.10.4. Units of measurement .....	79
9.10.5. Programming .....	79
9.10.6. System axes .....	79
9.10.7. G-codes .....	80
9.10.8. G92 - program zero point.....	80
9.10.9. G90 - absolute commands .....	80
9.10.10. G91 - incremental commands .....	80
9.10.11. G20 - imperial mode .....	80
9.10.12. G21 - metric mode .....	80
9.10.13. G00 - rapid travel.....	81
9.10.14. G01 - linear interpolation (motion in a straight line) .....	81
9.10.15. G02- G03 - circular interpolation (motion along a circular arc).....	81
9.10.16. G04 - pause/dwell .....	81
9.10.17. G40 - kerf off (compensation factor).....	81
9.10.18. G41 - kerf left .....	81
9.10.19. G42 - kerf right.....	82
9.10.20. G28 - return to reference point (zero position).....	82
9.10.21. G22 / G80 - cycle command (loop function) .....	82
9.11. M - codes.....	82
9.11.1. M00 - stop .....	82
9.11.2. M02 - program end .....	82

---

---

9.11.3. M07 - cutting sequence start .....	82
9.11.4. M08 - cutting sequence stop .....	83
9.11.5. Additional M-codes .....	83
<b>10. FAQ's Operating the system .....</b>	<b>84</b>
10.1. FAQ's Operating the system .....	85
10.2. Basic trouble shooting.....	87
10.3. Software service instructions - Boot menu.....	94
10.4. Backup and restore parameters .....	95
10.5. Changing System name text.....	97
10.6. Hardware service instructions.....	97
10.6.1. Replacing main fuse .....	97
10.6.2. Converting table for "Position Up Time" parameter.....	98
<b>11. Warranty terms and conditions.....</b>	<b>99</b>
S Mark; .....	100
CE Mark;.....	100
C-Tick Mark; .....	100
CSA Mark; .....	100
<b>12. Certification and compliance symbols.....</b>	<b>100</b>
Use and disposal of waste .....	101
Disposal of products at the end of lifetime .....	101
<b>Enclosure: Graphics library .....</b>	<b>102</b>
Shape 1 .....	104
Shape 2 .....	104
Shape 3 .....	104
Shape 4 .....	105
Shape 5 .....	105
Shape 6 .....	105
Shape 7 .....	106
Shape 8 .....	106
Shape 9 .....	106
Shape 10 .....	107
Shape 11 .....	107
Shape 12 .....	107
Shape 13 .....	108
Shape 14 .....	108
Shape 15 .....	108
Shape 16 .....	109
Shape 17 .....	109
Shape 18.....	109

---

Shape 19.....	110
Shape 20.....	110
Shape 21.....	110
Shape 22.....	111
Shape 23.....	111
Shape 24.....	111
Shape 25.....	112
Shape 26.....	112
Shape 27.....	112
Shape 28.....	113
Shape 29.....	113
Shape 30.....	113
Shape 31.....	114
Shape 32.....	114
Shape 33.....	114
Shape 34.....	115
Shape 35.....	115
Shape 36.....	115
Shape 37.....	116
Shape 38.....	116
Shape 39.....	116
Shape 40.....	117
Shape 41.....	117
Shape 42.....	117
Shape 43.....	118
Shape 44.....	118
Shape 45.....	118
Shape 46.....	119
Shape 47.....	119
Shape 48.....	119
Shape 49.....	120
Shape 50.....	120

**Enclosure 2: EX-TRACK® CNC Accessories.....121**

EX-TRACK® oxy fuel upgrade kit.....	121
Display protection cover polycarbonate 3 mm.....	121

**Enclosure 3: Spare parts.....122**

Exploded view A.....	123
Exploded view B.....	125
Exploded view C.....	127
Notes:.....	128
Revision history:.....	129



## SECTION 1.

### **SAFETY INSTRUCTIONS:**

---

1.1. General system safety precautions .....	12
1.1.1. System safety .....	12
1.1.2. Personal protective equipment .....	12
1.1.3. Safety precautions prior to handling and operation .....	13
1.2. Plasma/oxy fuel gas cutting safety awareness .....	14
1.2.1. Prevention of fire and explosion.....	14
1.2.2. Safe use of gas pressure regulators .....	14
1.2.3. Gas cylinder handling and storage .....	14
1.2.4. Oxy fuel gas hose safety precautions .....	14
1.2.5. Risk of fire .....	15
1.2.6. Risk of burn injury .....	15
1.2.7. Safety in the workplace .....	16

## Safety Instructions

Many accidents are caused by disregard for basic safety rules in the operation, inspection and maintenance of devices. So carefully read, fully understand, and comply with the safety measures and precautions described in this instruction manual and on the system before operating, inspecting, and maintaining the system.

### The system safety label categories are as follows:

#### WARNING



This symbol is used as a warning message or a warning label. It is positioned at places that could cause injury or serious accident.

#### CAUTION











This symbol is used as a caution message or a caution label. It is positioned at places that could cause slight injury or system damage. This is also used as a caution for highly dangerous actions.

#### NOTICE SIGNS



This symbol shows system operators and maintenance engineers items that relate directly to damage of systems and surrounding facilities and equipment.

**Warning symbols**

<b>Symbol</b>	<b>Title</b>	<b>Meaning</b>
	General	General caution, warning and danger.
	Be careful not to get your fingers caught!	Possible injury to fingers if caught in the insertion part.
	Caution: Electric shock!	Possible electric shock under special conditions.
	Ground this equipment.	Operators must ground the equipment using the safety grounding terminal on power plug.
	Pull out the power plug from the outlet.	Operators must unplug the power plug from the outlet when a failure occurs or when there is a danger of lightning and when performing all maintenance tasks.
	Caution against bursting.	Possible bursting of gas system under certain conditions.
	General	General warning.
	Caution: Hot!	Possible injury due to high temperature under certain conditions.
	Caution: Ignition!	Possible ignition under certain conditions.

## 1.1. General system safety precautions

### 1.1.1. System safety

The EX-TRACK® CNC System is fitted with an Emergency Stop or E-Stop Button. This button is used to isolate the system from the input (120V/220V) power source. It is intended for use in the case of an accident or emergency. The E-Stop Button is clearly located on the top of the Main Unit, to operate, press in to isolate the power to the CNC and drive mechanisms, none of the systems functions can operate. To restore power to the system, lift the E-Stop Button upwards, the screen will illuminate and all of the systems functions are restored.

1. The system casing is made from cast Aluminium and sheet metal, exercise care when handling, do not let the system drop from any height, and protect the system from falling objects.
2. Oxygen and fuel gas fittings and connections should be tightened using a suitable wrench, perform a leak test and retighten as required.
3. When fixing a nozzle to the oxy fuel torch, tighten the nut with two wrenches. In addition, avoid damaging the seat of the nozzle since this may cause flashback.
4. Never disassemble the system other than during maintenance and inspection. Otherwise, a system malfunction may occur.
5. Never modify the system. Modification can be very dangerous and voids the warranty.
6. Switch the power off when the system is not in use.
7.  Never use the system outside in the rain, the system may malfunction, this could result in serious injury or death.
8. This system is not intended for use with plasma cutting power supplies that utilize high-frequency (H/F) arc ignition.

### 1.1.2. Personal protective equipment

1. During operation, ensure that suitable personal protective equipment is used: gloves, gauntlets, goggles, face shields, safety shoes, and additional equipment as required.
2. Prohibit operation of the system if clothes or hands are wet, in order to prevent electric shock, electric shock can cause serious injury or death.

### 1.1.3. Safety precautions prior to handling and operation

1. Read and understand the content of this instruction manual before operating the system.
2. Before connecting the external power supply to the system, ensure that the system ON/OFF switch is set to OFF.
3. Before operating, check to confirm correct installation (based on EX-TRACK® CNC operator manual), ensure that the movement of the mechanism is unrestricted.
4. Prior to operating the system, check the work area for hazards in order to avoid accidents.
5. Never move or reposition the Longitudinal Guide Rail when in use, there is a serious risk of injury from Oxy fuel flame and plasma arc stream.
6. Keep the rail clean and free from debris, failure to do so can result in damage to the system, and the machine-guiding track, thus affecting the cut quality.
7. Care should be taken to prevent objects impacting/colliding with the track.
8. Prior to powering up the system, ensure that the OFF-Line button is depressed (OFF position). When the system ON/OFF switch is in the ON position, the OFF-Line button should NOT be illuminated. Failure to do so can result in injury.
9. To reduce the risk of an accident, prohibit the touching of moving parts while the system is running.
10. DO NOT use the EX-TRACK® for welding purposes the circuit boards will suffer catastrophic damage!
11. Do not operate the system during an earthquake.
12. Ensure correct connection of the oxygen and fuel gas hoses. Gas fittings/connections are screw threaded; ensure they are correctly tightened to prevent them becoming loose during operation.
13. If running the system in oxy fuel mode: when checking the running of system (dry run), ensure that the preheat oxygen valve and the fuel gas valve are in the OFF position.
14. After cutting, the cutting nozzle, torch and mountings may be hot, wear gloves if handling these parts.
15. Prevent the power cable and hoses from being trapped or crushed, ensure their free movement.
16. The EX-TRACK® system is not designed for use where it is mounted on soft ground or unstable surfaces.
17. Do not leave the system unattended when in use.
18. Hoses should be supported to reduce the risk of accidents/injury.
19. When a fuse frequently blows, to prevent damage to the system or injury to the operator, stop all use, the cause for the fuse failure requires investigation/repair before commencing work with the system.

## 1.2. Plasma/oxy fuel gas cutting safety awareness

It is essential that ALL operators of the system are aware of the potential danger/risk associated with Plasma/Oxy fuel Gas cutting operations. Keep "SAFETY" in mind!

### 1.2.1. Prevention of fire and explosion



1. Never cut into pressurized cylinders or hermetically sealed containers. Check for flammable liquids, gases, vapors and other combustible materials.
2. Ensure there is sufficient ventilation to safely use Oxy fuel gas or plasma cutting processes, use fume extraction/forced air systems as required.

### 1.2.2. Safe use of gas pressure regulators



1. Prior to use, perform a visual check on the regulators, look for physical damage to the body/gauges, check for a sticking pressure indicator, ensure the gauges are clean and dry.  
**Do not allow pressure regulators to come in to contact with oil or grease, this can lead to spontaneous combustion.**
2. Gradually open the cylinder/manifold valve (manifolds are used on multi-gas delivery systems) allowing the regulator to be pressurized without causing a sudden violent shock that can cause damage.
3. Check the pressure gauge dial to ensure the pressure indicator is not sticking, listen for gas leaks. Do not use damaged or leaking pressure regulators.
4. Do not attempt the repair of pressure regulators. Specialist training and equipment is required. Serious injury or death can result from tampering with the device.

### 1.2.3. Gas cylinder handling and storage



1. Never use cylinders that are damaged, have been used as rollers/supports or are leaking gas.
2. Cylinders should be stored/installed away from sources of heat, sparks, molten metal, and open flame. Kept in an upright position, take measures to prevent them from falling, secure using chains or other approved methods.
3. Cylinders are to be used for the specified purpose only.
4. Contact the cylinder supplier if there is difficulty in opening/closing the valve. Do not use force.

### 1.2.4. Oxy fuel gas hose safety precautions



1. The hoses are color coded, RED for fuel gas and BLUE (GREEN in North America) for oxygen, the hose fittings have dissimilar threads, the fittings on the fuel gas (RED) hose are "Left hand or Anti-clockwise" threads, the fittings have a small groove machined in to the external surface as an identification mark. The fittings on the oxygen (BLUE) (GREEN in North America) hose are "Right hand or Clockwise" threads.

2. Replace hoses that are showing signs of cracking, leaking, and damage caused by sparks, heat, open flame, crushed etc.
3. When installing hoses, do not over-tighten the fitting.
4. Exercise care when using/transporting hoses.
5. Do not drag the hoses when moving the system.
6. Perform Periodic safety checks to confirm the condition of the hoses, as a minimum the hoses should be free from signs of damage, age related wear/cracking with no gas leaks from the hoses or fittings.
7. Where possible use the minimum length of hose between the gas supply point and the EX-TRACK®, this reduces the risk of excess hose being damaged or causing a trip hazard. A shorter hose may improve gas flow.

### 1.2.5. Risk of fire



**Prior to cutting, survey the work area and assess the risk of fire. The cutting processes generate as a minimum hot molten metal and sparks. You are responsible for your own safety as well as others.**

1. The work area should be free from flammable liquids, gases, vapors and other combustible/flammable materials, ensure that suitable fire extinguishers for use on: Gas/Electrical/Hot metal fires are suitably located, locate fire buckets with sand/water as necessary.
2. Allow the parent material, profile cut parts and scrap time to cool down before moving them.
3. Never cut in to sealed or open canisters/containers that have been used for gases or flammable products.

### 1.2.6. Risk of burn injury



**Observe the safety precautions to avoid the risk of a burn injury. The oxy fuel and plasma cutting processes generate as a minimum hot molten metal, sparks and radiation, the effects can occur both during and after the cutting process.**

1. Do not cut near flammable liquids, gases, vapors or other combustible/flammable materials. Remove flammable materials from the work area, flying sparks are a source of ignition
2. Never cut into sealed or open canisters/containers that have been used for gases or flammable products.
3. Do not keep lighters or matches on your person.
4. When operating the EX-TRACK® system, maintain a safe distance from the torch.
5. To minimize the risk of injury, the appropriate Personal Protective Equipment must be worn.

6. For Oxy fuel cutting, ensure that the nozzle is correctly seated and tightened so as not to damage the seat/sealing area and prevent "Flashbacks" to the system.
  - When fixing a nozzle to the torch, use two wrenches to avoid damage to the torch. Over-tightening the nozzle will result in the nozzle overheating during the cutting process, making the nozzle more difficult to remove.
  - Damage to the taper of the nozzle can cause "Flashbacks".
7. An appropriate method of gas leak detection should be used to check the torch, hoses, connectors, vales and regulators, a suitable "Flashback Arrestor" compatible with selected gases should be fitted to reduce the risk of fire or explosion.

**DANGER!** DO NOT use oil or grease products on the Oxygen hose/torch/valve/regulator or connections, spontaneous combustion can cause a fire and lead to an explosion. To prevent any risk of cross contamination, it is advisable NOT to permit the use of oil or grease on any of the Oxy fuel supply or delivery components.
8. Check the following prior to igniting the Oxy fuel torch: Ensure that the torch is correctly seated and fixed in to the torch mount. The appropriate Personal Protective Equipment is to be worn/used. Check the work area for obstacles, hazardous/flammable materials. Check that the input and output gas pressures are correct and suitable for the job in hand.
9. Appropriate Personal Protective Equipment is to be worn/used when handling the torch, nozzle, idler wheel locking device, allow adequate time for the system to cool down after cutting.

### 1.2.7. Safety in the workplace

1. Use of the cutting processes will produce but not be limited to the following: Sparks, molten metal, high temperatures, thermal radiation, combustible gases, dust, noise, electric arc light, electromagnetic radiation. Serious injury can arise from failure to wear/use the appropriate Personal Protective Equipment during the cutting process. Flammable/highly combustible gasses are used in the Oxy fuel cutting process, exercise caution, gas leaks or misuse of the system could result in a fire, explosion and serious injury. Misuse of the cutting system may cause catastrophic failure of the equipment, resulting in explosive gas leaks/electric shock/burn injury.
2. The work area should be equipped with the most suitable fire extinguishing equipment, ensure that the correct extinguishing process is used for fire caused by but not limited to: gas leaks, electrical fault or hot metal. Not all fire extinguishing equipment is suited to extinguishing all fire types.
3. Implement strict adherence to the relative gas use regulations, cylinder storage, equipment pressure/condition checks, flashback arrestor checks etc.
4. Keep the work area free from flammable/combustible material. Use of the cutting processes will produce but not be limited to the following: Sparks, molten metal, high temperatures, combustible gases, dust. Fume extraction should be used in the work area, and this is in addition to the operator wearing/using Personal Protective Equipment.
5. Prior to starting the cutting process, the operator is to ensure that only authorized personnel are in the work area.



**ATTENTION:** Prior to starting the cutting process, perform a system/equipment check to ensure there are no gas leaks or visible damage to component parts. If during the cutting process there is the odor from a gas leak, immediately press the E-Stop button to isolate the electrical power supply, turn off the gas supply at the torch and then at the point of supply - Cylinder/Manifold. Do not use the system until it has been checked and deemed safe to use by a suitably qualified person. You are responsible for your own safety as well as others.

## **SECTION 2.**

### **LOCATION OF WARNING AND SAFETY LABELS:**

---

Warning and Safety labels have been affixed to the system for the purpose of hazard awareness and correct use of the system. Prior to operating the system carefully read the labels and follow the instructions. Do not remove labels. Always keep the labels legible.

# SAFETY

1



## **!Caution!**

The symbol shown in this section means: **!Caution!** !Beware!  
 ¡There are possible hazards with this procedure!

When you find this symbol in the manual or on the system, be cautious, and follow the related instructions to avoid the hazard.



## **Caution! Read operator's manual**

Follow the safety instructions to avoid danger.

Only qualified persons should install, operate, maintain and repair the system.

Keep out of reach of children.

2



## **PLASMA ARC RAYS CAN BURN EYES AND SKIN**

Arc rays from the cutting/gouging processes produce intense visible and invisible rays that can burn eyes and skin.

Use protective clothing made from durable, flame-resistant material, appropriate footwear and hand protection.

- Use face protection (welding helmet or shield) with the correct shade of filter lens fitted to protect your eyes and face (see Table 1.1).
- Warn people of the dangers of looking at the arc, use signs to warn/inform.



## **NOISE CAN DAMAGE HEARING**

Prolonged exposure to noise from plasma cutting/gouging can cause hearing damage.

- Use approved ear protection when operating the plasma system.
- Warn others about the dangers of noise.



## **FLYING SPARKS (ARC SPRAY) CAN CAUSE INJURY, FIRE OR EXPLOSION**

Flying sparks are created during the metal cutting/gouging processes; the area around the cutting process should be kept free from flammables.

- Use face shield/safety glasses with side protection.
- Wear flame resistant clothing, footwear and hand protection.
- Use earplugs/defenders that are flame resistant to prevent sparks entering the ear and to reduce the noise level.

3



### CUTTING CAN CAUSE FIRE OR EXPLOSION

#### FIRE PREVENTION

- Keep flammable items away from the work area.
- Ensure that there is a fully charged fire extinguisher in the work area
- Ventilate the work area, check for flammable/combustible gases, liquids and materials, remove prior to cutting as they present a fire risk.

#### EXPLOSION PREVENTION

- Do not cut in areas containing explosives, flammable gases or vapors.
- Do not place the system on, over, or near combustible surfaces.



### FLYING SPARKS (ARC SPRAY) CAN CAUSE INJURY, FIRE OR EXPLOSION

Flying sparks are created during the metal cutting/gouging processes; the area should be kept free from flammables.

- Use face shield/safety glasses with side protection.
- Wear flame resistant clothing, footwear and hand protection.
- Use earplugs/defenders that are flame resistant to prevent sparks entering the ear and to reduce the noise level.

- Do not operate the system in areas with an atmosphere containing high concentrations of dust, flammable gases or vapors.
- Do not use the system to cut pressurized containers that have not been de-pressurized, vented and cleaned.

4



### ELECTRIC SHOCK CAN KILL

Touching electrical parts could cause a fatal shock or severe burns.

- Do not touch live electrical components.
- Wear dry insulated gloves, shoes and protective clothing.
- Insulate yourself from the work and ground using dry insulating material large enough for the work area.
- The working area should be clean and dry.
- Switch OFF the system for cleaning and maintenance operations.
- Do not wrap cables around your body.
- Turn OFF the machine when not in use.

- Periodically check the power supply cable, to insure that the outer insulation is intact. Replace the power supply cable immediately if damaged. DO NOT use the system with bare or exposed wires, this is highly dangerous.
- Before removing the cover or handling any of the internal components of the system, wait 5 (FIVE) minutes to ensure complete discharge of the capacitors.
- Keep the system in good condition; repair or replace damaged parts immediately. Maintain the system in accordance with the manual.

5



### PLASMA ARC CAN INJURE

The plasma arc is activated immediately after the torch trigger is depressed.

- Turn off the power before changing the torch consumables, the plasma arc can burn through skin and gloves.
- Do not place your hand or hold the work piece near the cutting path.
- Do not point the torch toward yourself or other persons.



### HOT PARTS CAN CAUSE SEVERE BURNS

Caution! After cutting, the work piece will be HOT!

- Do not touch hot parts bare handed, wear suitable hand protection.
- Allow cooling time before handling.

6



**SMOKE AND GASES CAN BE HAZARDOUS**

Induction heating of certain materials, adhesives, and fluxes may cause fumes or smoke.

Breathing the fumes and smoke can be hazardous to your health

- Keep your face out of the smoke, do not breathe the fumes.
- Use local exhaust ventilation for fume removal.
- If ventilation is poor, wear an approved air-supplied respirator.
- Work in a confined space only if it is well ventilated, or while wearing an air-supplied respirator. The smoke and gases from the cutting/gouging process can displace air and lower the oxygen level causing injury or death.
- Monitor the breathable air quality as required.

7



**CAUTION WHEN CUTTING AROUND GAS CYLINDERS**

Gas cylinders which contain gas under high pressure can rupture and explode if damaged.

- Handle and use compressed gas cylinders in accordance with local or national codes.
- Never allow electrical contact between the plasma arc and a cylinder.
- Never expose cylinders to excessive heat, sparks, slag or flames.



**MAGNETIC FIELD CAN AFFECT PACEMAKERS**

- People with pacemakers/hearing aids should avoid close contact with plasma arc power supply.
- People with pacemakers/hearing aids should consult their doctor before operating plasma arc power supply.



**Do not exceed the recommended duty cycle, this can lead to overheating and cause damage to the system.**

- Allow a suitable cooling off period with high demand usage.
- Observe the duty cycle rating shown on the label attached to the system.



**PLASMA CUTTING CAN CAUSE INTERFERENCE**

- Electromagnetic energy can interfere with sensitive electronic equipment such as computers, or computer-driven equipment.
- Ensure that all equipment in the cutting area is electromagnetically compatible.
- Ensure that the plasma arc cutting system is installed and positioned in accordance with this manual.

Plasma Arc Cutting Current	Protection glass shade number per ISO 4850:1979
Up to 150A	ISO (DIN) 11
150A to 250A	ISO (DIN) 12
250A to 400A	ISO (DIN) 13
OVER 400A	ISO (DIN) 14

Table 1.1

## SECTION 3.

### SPECIFICATION:

---

3.1. System overview .....	23
3.1.1. Main features .....	23
3.1.2. Range of application.....	23
3.2. System parts description .....	23
3.3. Technical parameters .....	24
3.4. Torch height controller.....	25
3.5. Gas supply .....	25

### 3.1. System overview

The EX-TRACK® CNC Cutting System is the latest generation of high precision, programmable and portable cutting system designed for use in the workshop or on site.

#### 3.1.1. Main features

The system has a similar functionality to the fixed table type equipment fitted with a large gantry. This system is fitted with an Oxy fuel cutting torch, a Plasma cutting torch, or both. The CNC function enables the system to cut complex shapes with high accuracy and repeatability, there is also the manual cutting function for the simpler applications. The system is transportable, it can be easily carried by two people to the job site.

The EX-TRACK® CNC System is simple and easy to use and is fitted with a 7" high resolution LCD display. It can be manually programmed; it is able generate its own programs from a library of common shapes; alternatively, programs can be loaded through the USB port from off-line programming software. AutoCAD parts drawings are stored directly in DXF file format.

#### 3.1.2. Range of application

The EX-TRACK® CNC Cutting System is versatile in its functionality, it can be used with Oxy fuel or Plasma to produce one off or multiple parts and from simple to complex shapes. The system has been designed for industry wide use: Petrochem, Shipyards, Wind Turbines, Off/On-shore, Pressure Vessel manufacture, Sheet Metal shops, and more.

### 3.2. System parts description

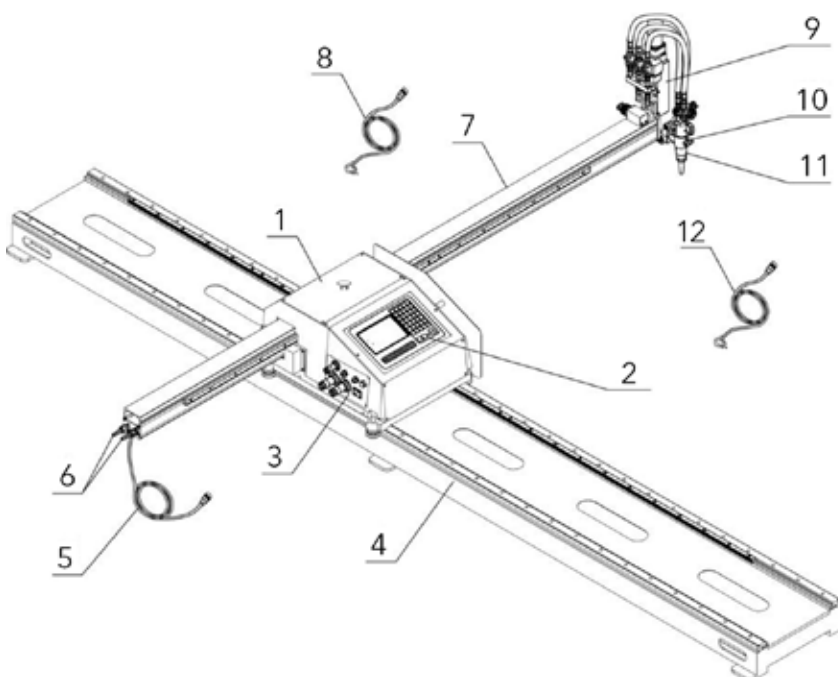

1. Main unit
2. CNC/Operator Panel
3. Power in/connection panel
4. Longitudinal guide rail
5. Torch height motor lead
6. Oxy fuel input connectors
7. Transverse guide rail
8. Power lead
9. Torch height controller
10. Torch mounting assembly
11. Torch assembly
12. CNC connection lead

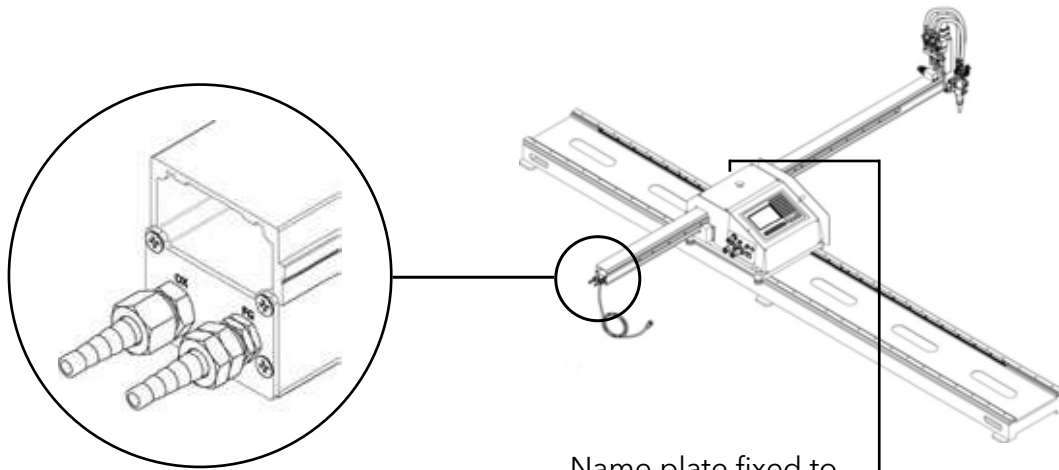

**Oxy fuel input connectors:**

OX - Oxygen

FG - Fuel gas (Propane)

Name plate fixed to the back of the main unit.



CE Name plate

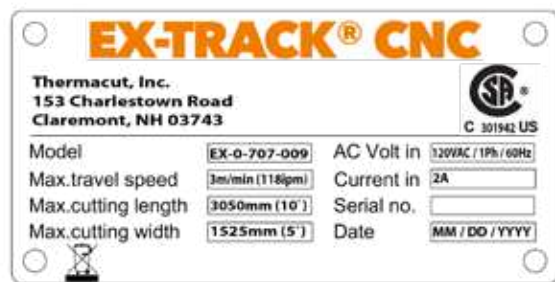

CSA Name plate

**WARNING:** Do not use EX-TRACK® CNC unit with high frequency ignition plasma systems! HF ignition can damage the unit.

### 3.3. Technical parameters

Cutting area (mm)	1500 × 3000
Supply voltage	AC110V/230V - 50HZ
Cutting torch	1
Cutting speed (mm/min)	50-3000
Maximum position speed (mm/min)	3000
Overall dimensions (l × h × w) (mm)	3500 × 370 × 2200
Weight (kg)	145



### 3.4. Torch height controller

**Oxy fuel Torch:** comprises of torch body, two-way valve, gas supply hoses and fittings.

**Plasma Torch:** comprises of torch body, mounting tube, combined power cable/air hose lead set and consumables.

**Torch lifting mechanism:** comprises of lifting motor, lifting screw, guide shaft and fittings.

**Torch mounting assembly:** comprises of connector, clamp and manual lifting wheel. The torch height and vertical positioning can be adjusted manually, so as to ensure that cut is square. For edge beveling, rotate the torch along the longitudinal or transverse direction to perform an angled cut.

### 3.5. Gas supply

The system uses oxygen and fuel gas hoses for the delivery of gases to the torch; Gas ignition and flame adjustment are performed manually.

**DO NOT USE ACETYLENE FUEL GAS WITH THIS SYSTEM!**

See Section 5.2 for operation.

## SECTION 4.

### UNPACKING AND ASSEMBLY:

---

4.1. Packing list.....	27
4.2. System assembly .....	28
4.2.1. Parts check .....	28
4.2.2. Fitting the main unit on to the longitudinal guide rail.....	28
4.2.3. Fitting the transverse guide rail.....	29
4.2.4. Fitting the torch height controller .....	29
4.2.5. Gas supply connection .....	30
4.2.6. Electrical connection .....	30

## 4.1. Packing list

Upon receipt of the system, check that all parts have been received and that they are undamaged. shortages or damage, contact your supplier.

Number	Name	Quantity	Note
<b>Assembled parts</b>			
1.	Main unit (CNC unit)	1	
2.	Transverse rails	1	Aluminum profile
3.	Longitudinal rails	1	
4.	Torch assembly	1	
5.	Power lead and Plasma Interface cable	1	length 3m
6.	CNC cable	1	length 6m
<b>Technical literature</b>			
1.	Instruction manual	1	
2.	Programming software CD	1	
3.	USB Dongle for Programming Software	1	
4.	Certificate	1	
<b>Supplied accessories</b>			
1.	Propane/Natural Gas cutting nozzle	3	G02
2.	Oxy fuel Nozzle cleaning kit	1	
3.	Wrench	1	

## 4.2. System assembly

### 4.2.1. Parts check

Check that the main parts listed below have been received. Change lifting device to:

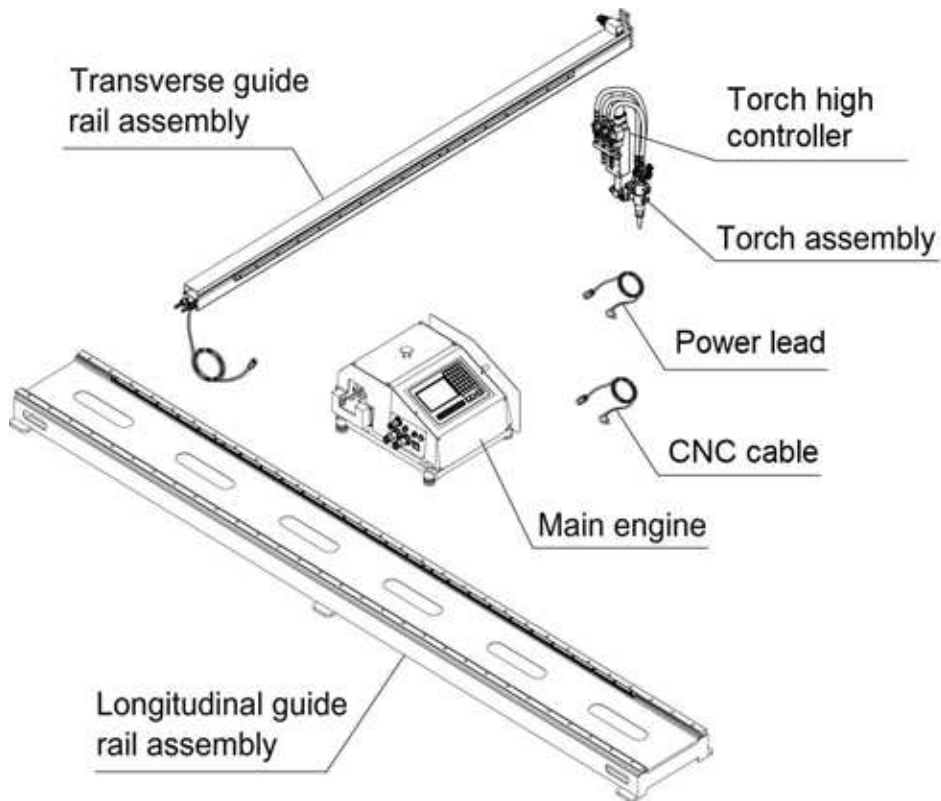

### 4.2.2. Fitting the main unit on to the longitudinal guide rail

Main rail **MUST BE** secured or fixed to a heavy table/construction, which cannot tip over, preferably also secured to the floor. Then carefully feed the main unit on to the rail guide (it is recommended that this is done with two people). Gently feed the main unit on to the guide rail until the main unit drive assembly is fully engaged with the drive rack. The main unit will now travel freely on the guide rail. Ensure that the guide rail end stop is fitted; tighten to prevent the main unit from disengaging the guide rail. **Failure to fit/tighten the end stop could result in personal injury and or damage to the main unit.**

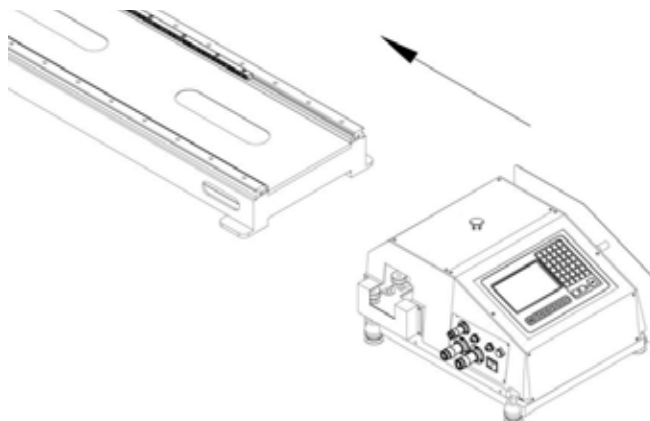

### 4.2.3. Fitting the transverse guide rail

Pass the torch height motor lead (complete with plug) through the main unit case, then place the transverse rail in the horizontal plane, as shown in Figure 3, gently feed the rail in through the main unit until the rack meshes with the drive gear in the main unit.

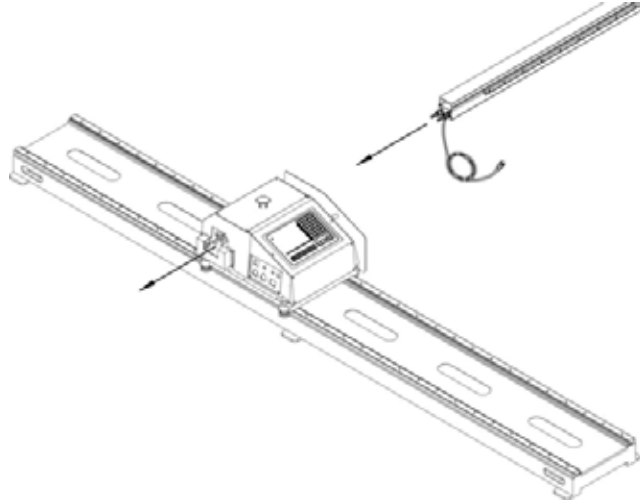

### 4.2.4. Fitting the torch height controller

Fit the torch height controller to the transverse guide rail using the four M5 × 10 Allen screws and tighten.

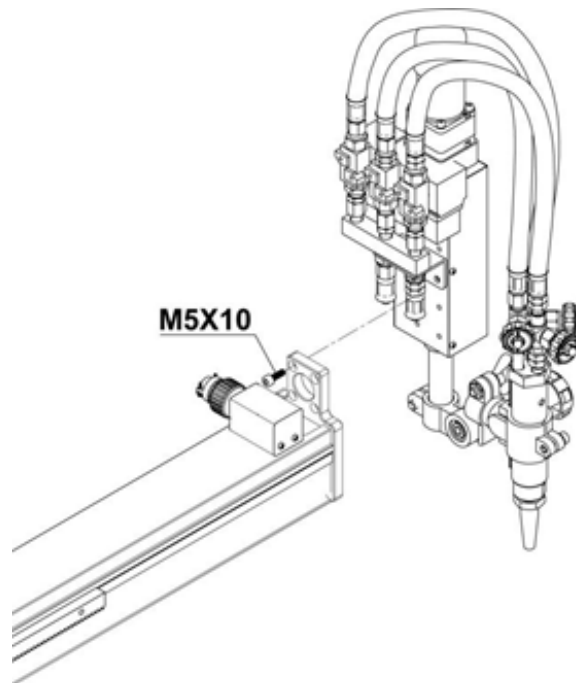

### 4.2.5. Gas supply connection

Connect the oxygen and fuel gas hoses to the manifold.

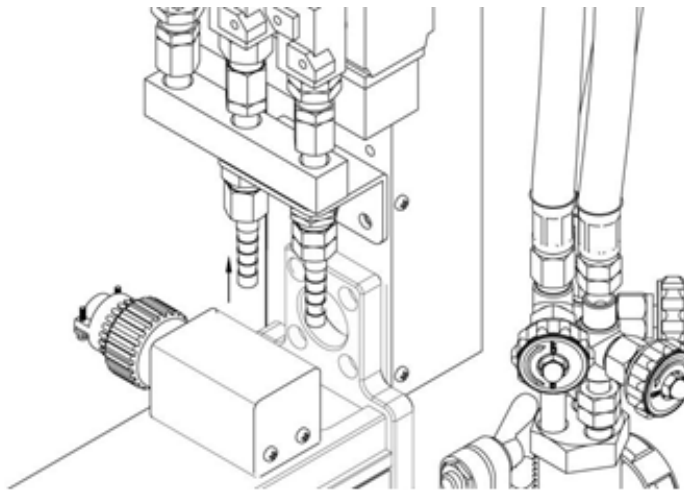

#### **NOTE: OXY FUEL HOSE SAFETY**

The hoses are color coded, RED for fuel gas and BLUE (GREEN in North America) for oxygen, the hose fittings have dissimilar threads, the fittings on the fuel gas (RED) hose are "Left hand or Anti-clockwise" threads, the fittings have a small groove machined in to the external surface as an identification mark. The fittings on the oxygen (BLUE - or GREEN in North America) hose are "Right hand or Clockwise" threads.

When the connection of the gas cutting equipment has been completed, a full working pressure leak test should be performed. Use a suitable leak test product, ensure that there are no leaks prior to use.

The Oxy fuel hoses fitted to this system are standard Ø8mm internal diameter hoses. Where possible use the minimum length of hose between the gas supply point and the EX-TRACK®, this reduces the risk of excess hose being damaged or causing a trip hazard. A shorter hose length may improve gas flow.

### 4.2.6. Electrical connection



Check the input power voltage of the system before operation. The input power voltage should be in the range of  $\pm 10\%$  of the rated voltage. The system should not be operated outside of the range specified on left side panel.

Insert the plug for the torch height motor (four pins) into the socket on the side of the main unit. Connect the power lead to the main unit. (AC220V/AC120V for US). Connect the oxygen and fuel gas supply hoses and tighten.

Plug the torch height motor control lead in to the corresponding input on the main unit side panel.

Ensure that there is a functional ground terminal on the input power lead. If not grounded, the operator is at risk of an electrical shock.

### Grounding (earthing) the system



The Power lead of this system is equipped with a grounding wire (earth), it is to be plugged in to a mains/network socket that is equipped with a mating ground (earth) terminal, connection and supply are to be in accordance with local electrical codes and regulations.

**Stop operation and cut off the power in the following cases, inform a suitably qualified person, do not use the system until it is fully repaired/functional.**



- Broken or abraded cables.
- Water has entered the main control unit.
- All settings are In accordance with the operating manual, but the system runs erratically.
- The system stops functioning.

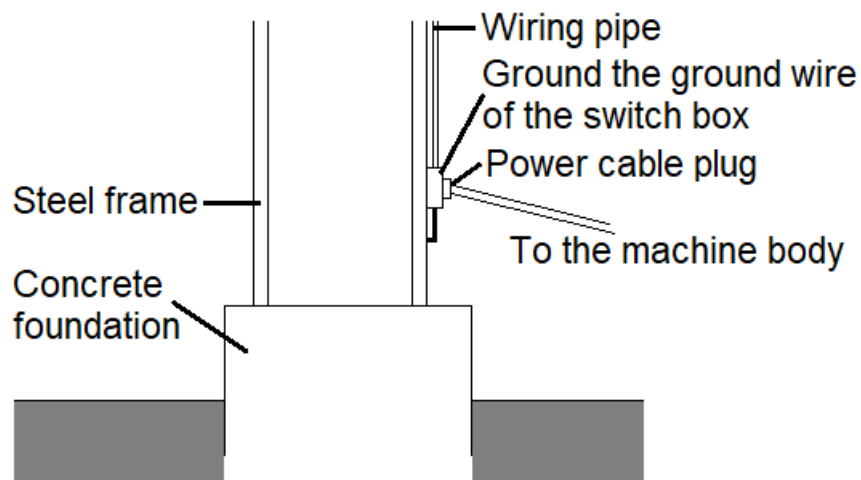

---

**SECTION 5.****CUTTING PROCESS:**

---

5.1. Prior to operating the system.....	33
5.1.1. Input voltage settings .....	33
5.1.2. EX-TRACK® placement .....	33
5.1.3. Oxy fuel nozzle choice.....	33
5.1.4. Regulated gas supply .....	33
5.1.5. Oxy fuel cut charts.....	33
5.1.6. Pre-ignition check.....	34
5.2. Ignition and flame adjustment - oxy propane cutting .....	34
5.3. Cut quality .....	35
5.4. Preheat time .....	35
5.5. Torch operation.....	35
5.6. Flashback and backfire prevention .....	36
5.6.1. Flashback prevention .....	36
5.6.2. Backfire prevention .....	36



## 5.1. Prior to operating the system

### 5.1.1. Input voltage settings

The CE model of CNC unit is pre-adjusted from the production on 230VAC. The CSA model of CNC unit is pre-adjusted from the production on 110VAC.

If you need to switch the input voltage, open the CNC unit and switch the switching power supply to your desire input voltage (in regards with your local standart or directives).

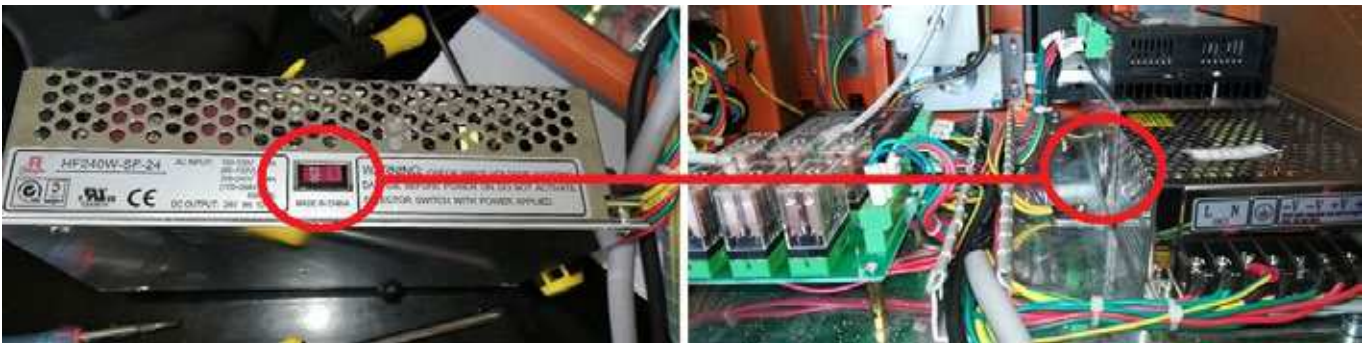

### 5.1.2. EX-TRACK® placement

The EX-TRACK® is to be sited on a well-supported foundation, ensure it is leveled prior to use, do not walk or step on the rail.

### 5.1.3. Oxy fuel nozzle choice

Reference the cut-charts; select the correct size cutting nozzle according to the thickness of the steel plate. Select a larger size nozzle if the steel is heavily rusted, or for bevel cutting at angles greater than 20°.

### 5.1.4. Regulated gas supply

The EX-TRACK® CNC Cutting System requires a regulated supply of oxygen and fuel gas, the use of an unregulated gas supply can cause damage to the system and lead to personal injury or death. Regulators are required to suitably control the flow of gases, incorrect pressures can result in, but be not limited to, poor cut quality and reduced lifetime of consumables.

### 5.1.5. Oxy fuel cut charts

The cut charts are a guide for the operator, due to the varying types and quality of steel, climatic/ atmospheric conditions, it is advisable to make the relevant setting and adjustments to suit the work in hand.

Part Nr.	Nozzle type	Work-piece thickness (mm)	Torch height (mm)	Pressure (bar)			Consumption (NI/h)			Cutting speed (mm/min)
				Preheat O <sup>2</sup>	Cutting O <sup>2</sup>	Fuel gas (propane)	Preheat O <sup>2</sup>	Cutting O <sup>2</sup>	Fuel gas (propane)	
EX-0-708-017	00	1-5	8-10	1,5	2,0	0,2	1180	1200	310	750-550
EX-0-708-018	0	5-10	8-10	1,5	2,3	0,2	1180	1200	310	600-450
EX-0-708-019	1	10-20	8-10	1,5	2,5	0,2	1370	2300	310	480-380
EX-0-708-020	2	20-35	8-10	1,5	3,0	0,25	1370	4300	360	400-320
EX-0-708-021	3	35-60	8-10	1,5	3,5	0,3	1860	6500	490	350-280
EX-0-708-022	4	60-90	8-10	1,5	4,5	0,3	1860	11000	490	300-240

### 5.1.6. Pre-ignition check

Prior to the torch being ignited, it is advisable to make a dry run on the workpiece, ensuring that the cut path matches the profile shape required.

## 5.2. Ignition and flame adjustment - oxy propane cutting

The following information relates solely to Oxy Propane cutting, for alternative gases such as Acetylene, seek advice from your gas supplier. Use the cut chart data as a guide, adjust the gas flow pressure at the regulator, after ignition further adjustment to the flame may be required.

1. Unscrew the fuel gas valve on the torch, a 1/4 turn.
2. Unscrew the oxygen preheating valve on the torch, a 1/2 turn and ignite the gas flow at the torch tip.
3. Gradually unscrew the fuel gas valve and oxygen preheating valve on the torch, until the required Neutral flame is achieved. See images of the carburizing, oxidizing and neutral flame profiles.
4. Approximate distance between the cutting nozzle face and the workpiece:  
Propane gas 8 - 10mm
5. A neutral flame, correct nozzle size, travel speed and torch height are required to achieve the desired profile cut finish. The cleaning of profile parts is easy when all parameters are set correctly.
6. Ensure the nozzle size used is suited to the material thickness, a nozzle that is too big in size for thin material will cause the material to distort and have a poor cut quality, likewise, a nozzle that is too small for thick material will travel too slow, cause edge damage and possible incomplete severance of the part. Flashbacks can occur from cutting with incorrect settings, ensure "Flashback Arrestors" are fitted, used correctly and maintained.
7. To maintain a constant cut quality, ensure settings are adjusted as required, use the supplied nozzle cleaning kit to keep the nozzle clean and free from dross and spatter.

### 5.3. Cut quality

Acceptable cut quality is dependent upon many factors, quality that is acceptable in some instances may not be for others. Make a test cut prior to a production run to ensure the required cut quality has been achieved.

Use the images below as a guide to correct travel speed.

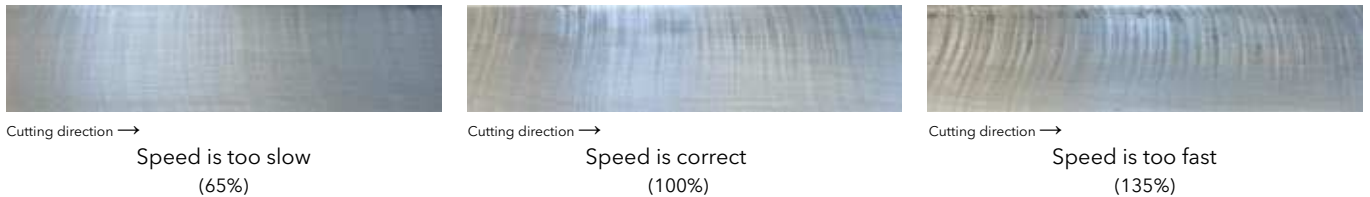

### 5.4. Preheat time

Preheat time for edge starts or piercing are dependent upon nozzle size, flame value, material type/thickness and ambient temperature of the material. The chart below is intended as a guide to preheat times, actual times may vary.

Average preheating time (in seconds min. / max.)	
Work-piece thickness	Propane
Up to 20 mm	8 / 34
To 50 mm	10 / 53
To 100 mm	22 / 100

**Note:** Incorrect piercing of thick material can result in damage to the nozzle, torch and system, for cutting 50mm thickness or greater, use the running or flying pierce technique, this should be performed only by experienced operators. Using a drilled hole is an alternative method for piercing thick material, this enables an edge start to the cutting process. Frequently check the nozzle for debris build up or damage, a blocked or damaged nozzle can cause flashbacks and poor cut quality.

### 5.5. Torch operation

Prior to the torch being set in motion, the operator needs to ensure that the work area is free from flammable and combustible materials, the system can be operated without colliding with structural, fixed or moving objects, the work area shall be cleaned, free from material off cuts and checked for slip, trip and fall hazards.

Turning the torch off. Upon completion of the cutting process, raise the torch, turn off the cutting oxygen supply at the torch, turn off the fuel gas supply at the torch and the turn off the oxygen cut

preheat gas supply at the torch. At the end of the shift, raise the torch and “home” the torch to where the mid-point of the transverse rail is resting in the main unit, isolate the system from the main gas and electrical power supply.

## 5.6. Flashback and backfire prevention

### 5.6.1. Flashback prevention

Flashbacks can cause serious damage, injury or death, ensure that flashback arrestors are fitted to the oxygen and fuel gas regulators. The effect of a flashback is where there is a loud explosion, the flame disappears inside the torch head, the torch head and hoses become intensely hot, a whistling or hissing noise comes from the torch, immediately press the E-Stop button, turn off the fuel gas at the torch, then close off the heating and cutting oxygen supply. Wear gloves when turning off the gas supply at the torch, it may be extremely hot. Close off ALL gas supply at cylinders or manifolds. Do not operate the system until a suitably qualified person has checked the system and found the reason for the flashback. In certain countries it is mandatory for flashback arrestors to be fitted to the torch as well as the regulators. It is the operator’s responsibility to ensure compliance with local, national and international rules and regulations pertaining to the use of oxy fuel cutting equipment.

Flashbacks can arise from but be not limited to the following causes:

1. Incorrect gas pressure
2. Cutting nozzle overheating.
3. Cutting nozzle blocked by spatter or slag.
4. Incorrect nozzle size.
5. Damage to nozzle seating area.

The supplied flashback arrestor is built in on the fuel gas supply at the torch, it is intended for use with Propane gas only, do not use it for any other gases.

**The EX-TRACK® CNC System is not set up for Acetylene gas use.**

### 5.6.2. Backfire prevention

A backfire may be caused upon ignition, or during the cutting process, due to incorrect gas pressure, incorrect oxygen/fuel gas mixture at the nozzle or loose mill scale/rust adhering to the nozzle tip. Backfires are identified by a violent popping sound; the flame either extinguishes or re-ignites at the nozzle. Immediately stop the cutting process and establish the cause before restarting the process.

**Turning the torch off:**

1. Close the oxygen preheating valve.
2. Close the fuel gas valve.
3. Close the oxygen cutting valve.

## SECTION 6.

### SYSTEM OPERATION:

---

6.1. Oxy fuel cutting (prior to operation) .....	39
6.2. Plasma arc cutting (prior to operation).....	40

## 6.1. Oxy fuel cutting (prior to operation)

1. Check the torch, valves, flashback arrestors and fittings for tightness, unrestricted access and condition.
2. Check that the gas inlet pressure does not exceed the system maximum.
3. Check that the power supply input voltage is correct and complies with regulatory requirements.

### In operation

1. Whenever possible, keep the material to be cut parallel to the longitudinal rail.
2. Select the correct size nozzle to suit the material being cut, check the torch alignment for squareness to the material being cut.
3. Input the parameters for material thickness, set the preheat and cutting time, set the oxygen cut flow pressure and cut speeds in accordance with the relevant cut charts.
4. Prior to torch ignition, the work area should be vacated by non-essential personnel. Operators should use the most appropriate piercing method to reduce flying sparks and damage to the torch/nozzle and system.
5. Ensure the flame is Neutral, test the oxygen cutting jet, if the nozzle is fouled up or damaged, either clean the nozzle using the cleaning kit provided or fit a new nozzle.
6. If during the cutting process a flashback occurs, press the E-Stop button then immediately turn off the fuel gas at the torch, then close off the heating and cutting oxygen supply. Wear gloves when turning off the gas supply at the torch, it may be extremely hot. Close off ALL gas supply at cylinders or manifolds. Do not operate the system until a suitably qualified person has checked the system and found the reason for the flashback.
7. Whilst operating the system, the operator should remain vigilant and be aware any unusual changes to the operating system and the work area, upon discovery of a fire, gas leak or other danger, the operator should press the E-Stop button, and turn off the gas at the torch if safe to do so, or isolate the gas supply at the cylinder/manifold.
8. The operator should be aware that after cutting a profile, the torch should be raised to prevent a collision when moving to the next start point.
9. When using an overhead crane or other lifting device to move the cut profiles or scrap material, ensure that the EX-TRACK® will not be damaged.

### End of shift / day

1. Ensure that the torch is in the home position, close all gas valves and isolate the system from its electrical supply.
2. Clean down the main unit, rails and rack, use lubricants as required, do not use excessive amounts of lubricant as this will attract contaminants.
3. Leave the work area clean and tidy, with tools correctly stored.

## 6.2. Plasma arc cutting (prior to operation)

1. Fit the main power lead, check that the input voltage is correct, the main power lead plugs in to the EX-TRACK® on the left side Power in/Connection Panel, and check for a secure fit.
2. Connect the plasma power supply to the EX-TRACK® CNC System using the Plasma Interface Cable, the cable plugs in to the EX-TRACK® on the left side Power in/Connection.
3. Fit the torch height controller lead from the transverse rail to the EX-TRACK® on the left side Power in/Connection.
4. Feed the plasma torch lead set through the transverse rail (it may be necessary to remove the rail cover) and fit the torch in to the torch mounting. Secure the torch after checking its alignment, check for free movement.
5. Inspect the consumables, replace as required and check fit up.
6. Refer to the plasma power supply Instruction Manual for additional setup guidance.

### In operation

1. Whenever possible, keep the material to be cut parallel to the longitudinal rail.
2. Refer to the plasma power supply cut charts to ensure they correspond with the values shown in the CNC system.
3. Prior to plasma arc ignition, the work area should be vacated by non-essential personnel. Operators should use the most appropriate piercing method to reduce flying sparks and damage to the torch/consumables and system
4. Adjust the cutting parameters accordingly through the CNC program.
5. Whilst operating the system, the operator should remain vigilant and be aware any unusual changes to the operating system and the work area, upon discovery of any form of danger, the operator should press the E-Stop button.
6. The operator should be aware that after cutting a profile, the torch should be raised to prevent a collision when moving to the next start point.
7. It is advisable to wear gloves when changing consumables as the torch may be hot from the cutting process, there may also be sharp deposits of spatter/dross stuck to the consumables.
8. When using an overhead crane or other lifting device to move the cut profiles or scrap material, ensure that the EX-TRACK® will not be damaged.

### End of shift / day

1. Ensure that the torch is in the home position, isolate the system from the electrical input power supply and from the plasma power supply.
2. Clean down the main unit, rails and rack, use lubricants as required, do not use excessive amounts of lubricant as this will attract contaminants.
3. Leave the work area clean and tidy, with tools correctly stored.



## SECTION 7.

### MAINTENANCE:

---

7.1. Cleaning the system.....	42
7.2. System lubrication .....	42
7.3. Drive motor adjustment.....	42
7.4. Oxy fuel nozzle maintenance .....	42



To keep the system in optimum condition, it is necessary to perform regular maintenance and service. The following is a minimum requirement, dependent upon actual work conditions, maintenance and service may need to be performed more frequently, it is advisable to setup a maintenance schedule.

## **7.1. Cleaning the system**

It is a requirement that the EX-TRACK® CNC Cutting System is checked for cleanliness prior to, during and after the cutting process. Prior to any cleaning, isolate the electrical power supply to the system. The drive mechanisms for the longitudinal and transverse rails needs to be checked for any buildup of debris/dust/scale/slag, using a clean cloth/soft brush, clean down the area, do not use abrasive cleaning tools such as a steel wire brush, this will damage the material surface, making it more prone to contaminants sticking and building up. The track and rack should be constantly monitored for debris buildup, use a soft brush, cloth or clean dry compressed air to remove any contaminants, lubricants may be used on the rack, but sparingly as excessive lubricant will attract a contaminant buildup. Keep the system main unit clean, use a soft cloth to wipe down the CNC/operator panel, ensure that the USB port cover is fully closed when not in use and keep the surrounding area clean.

## **7.2. System lubrication**

Prior to each use of the system, the operator should ensure that the drive mechanisms have been lubricated. An indication of excessive wear to the drive mechanism or rack is noted when cut parts display an irregular edge surface.

## **7.3. Drive motor adjustment**

After a period of use, it is normal for working parts of the system to show varying degrees of wear. A suitably qualified person can perform adjustments to the drive motors to realign the system and maintain cutting accuracy.

## **7.4. Oxy fuel nozzle maintenance**

Cut quality is affected by the condition of the nozzle, in order to clean and maintain the nozzle correctly, the nozzle should be removed from the torch, use two wrenches for this action. Inspect the nozzle for wear, remove any spatter/dross/slag or soot buildups, do not use a steel wire brush, and use the supplied nozzle kit to clean the nozzle. Re-fit the nozzle after cleaning, check for leaks and make a short test cut to ensure that the nozzle is cutting true.

Empty page.

## SECTION 8.

### CIRCUIT DIAGRAM:

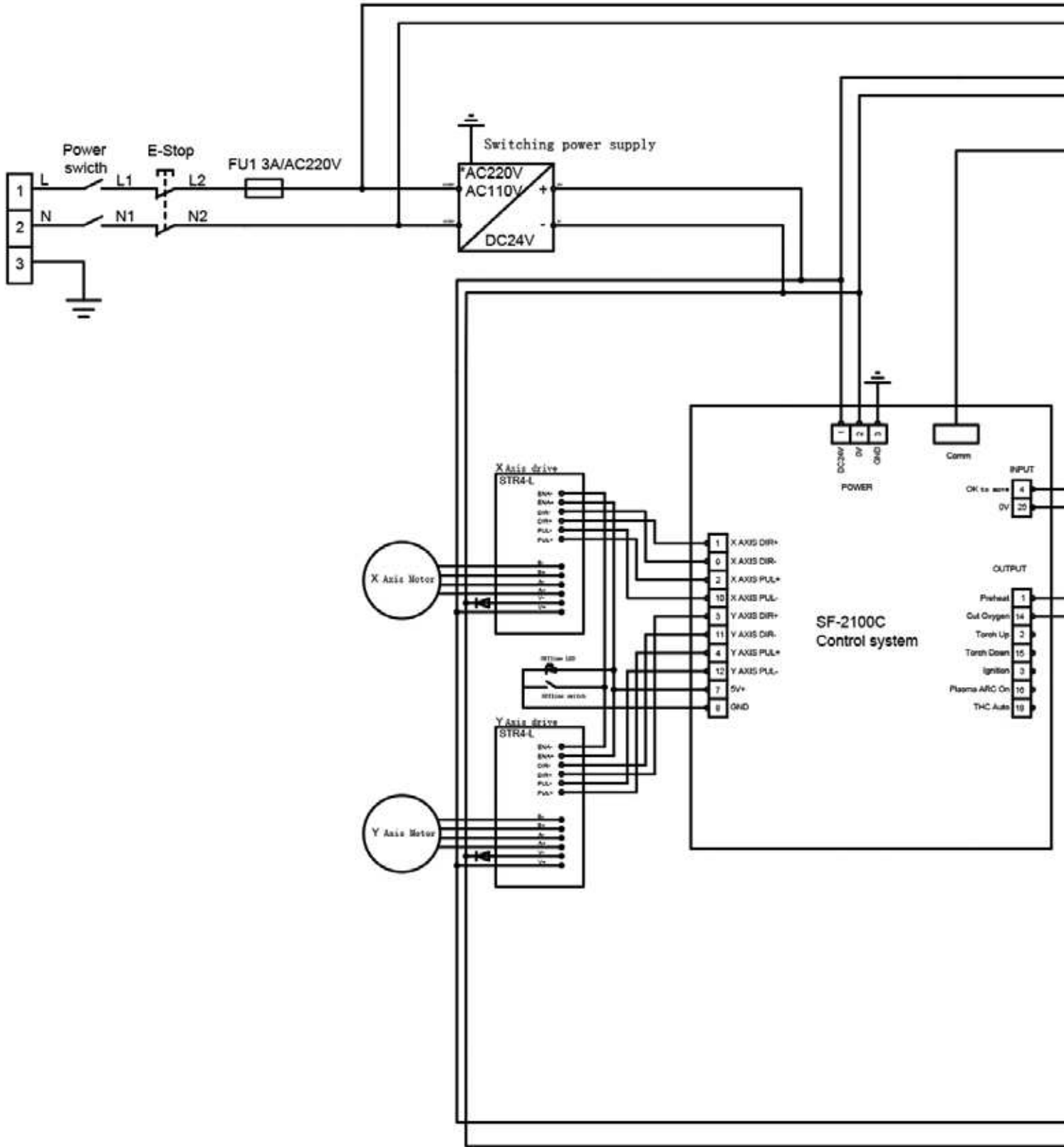

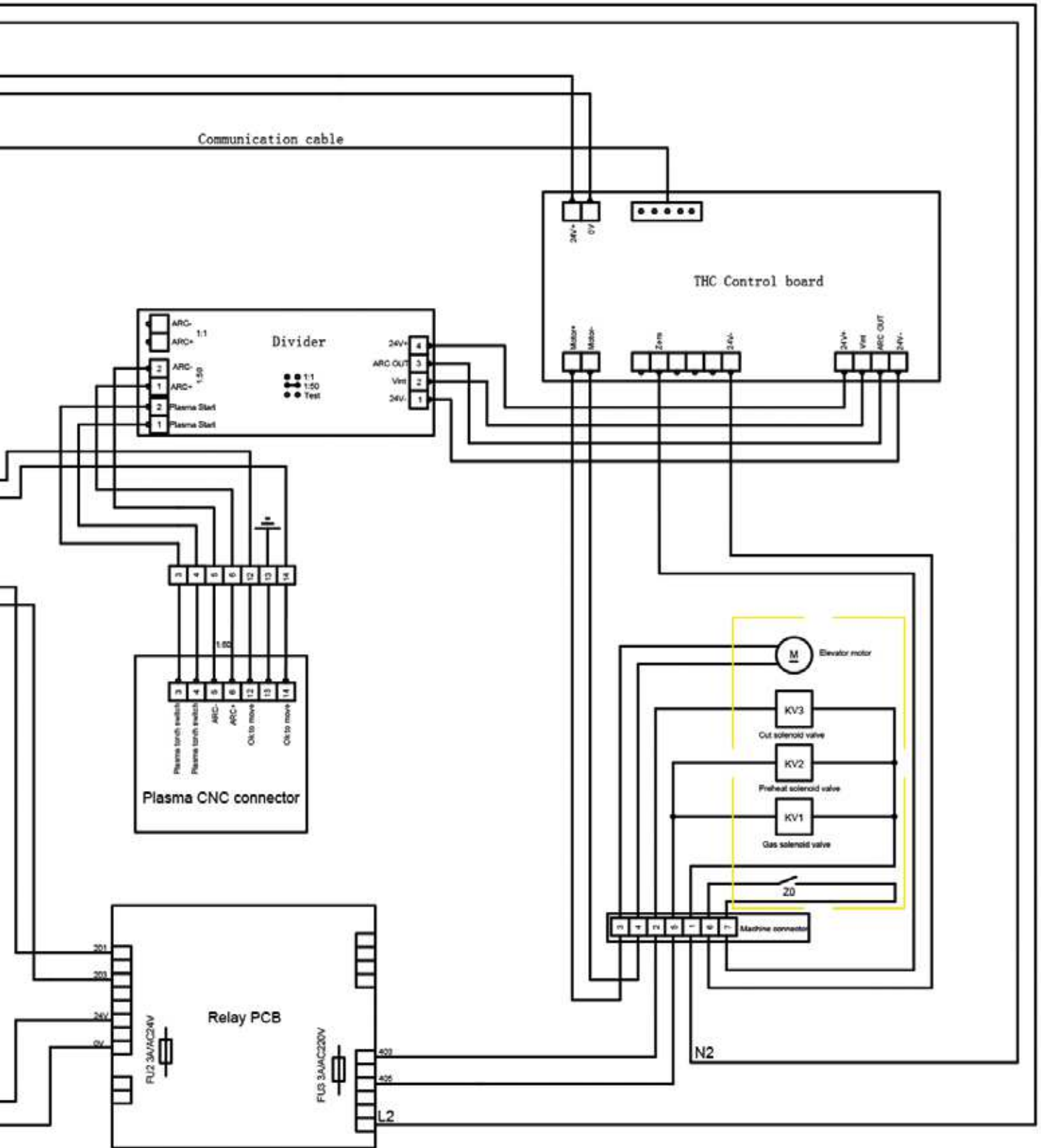

## 8.1. Plasma interface

### SYSTEM CNC INTERFACE CONNECTION

Each type of signal is available through the system CNC interface connector located on the left side of the main unit. Use the chart with details of each signal type below when connecting the system interface lead to the plasma arc power supply.

Signal	Start	Arc Trans	Voltage Divider
Type	Output	Input	Input
Note	Normally open. Dry contact.	Normally open. Dry contact from plasma.	Arc divider Voltage signal of: 50:1 from plasma.
Pin	3 - 4	12 - 14	6 - 5

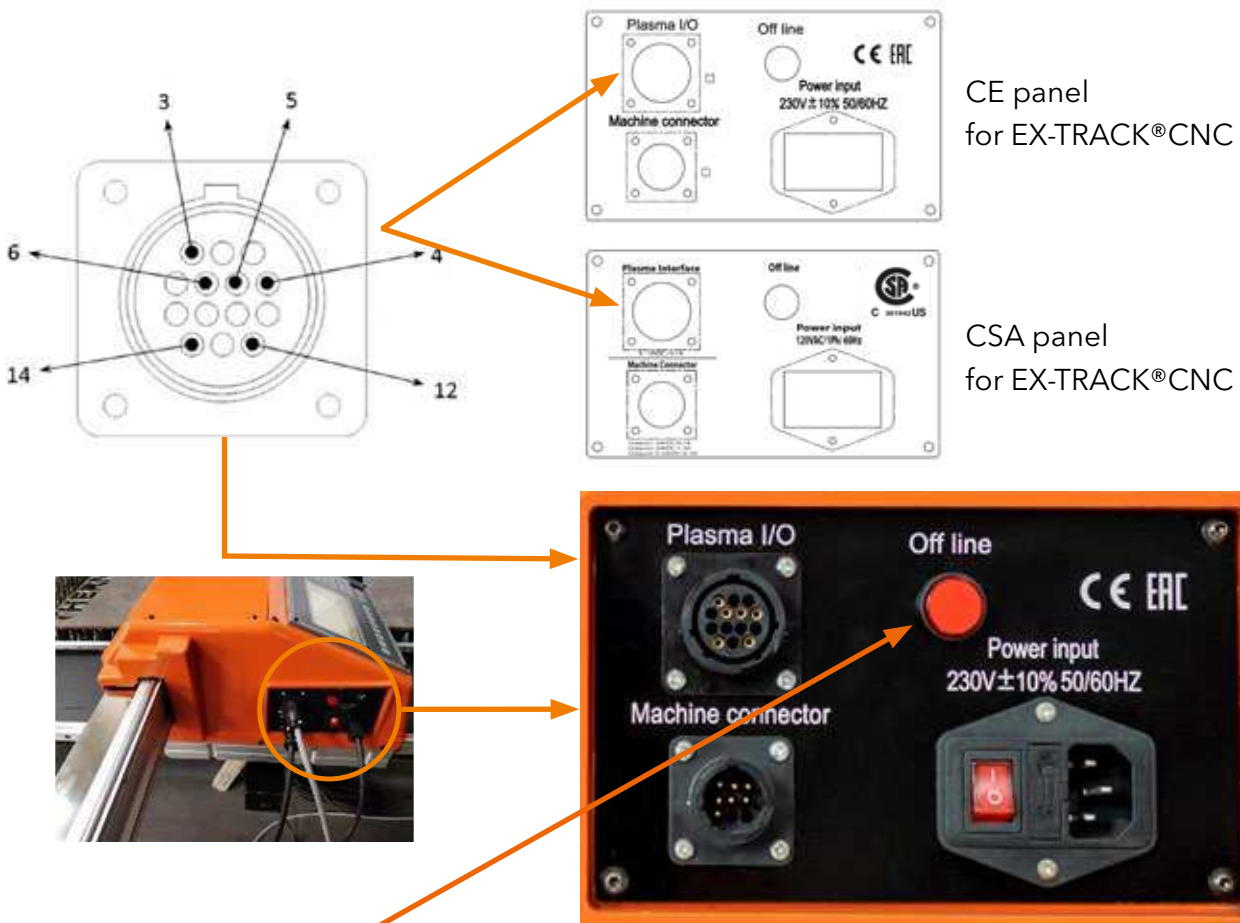

**Drive Engage/Disengage:** In the OFF LINE position, power is removed from the gear drives so the system can be manually positioned in either axis. In the ON position the drives are engaged for normal operation.

## SECTION 9.

### OPERATION:

9.1. Control panel functions .....	50
9.2. CNC system functions.....	50
9.3. System main menu .....	51
9.3.1. Menu features.....	51
9.3.2. Main function F-key menu.....	52
9.4. Automatic function .....	52
9.4.1. Interfaces and inputs .....	53
9.4.1.1. Speed .....	53
9.4.1.2. Prog, pierce, kerf .....	53
9.4.1.3. Work mode - running status .....	53
9.4.1.4. Input and output signals .....	53
9.4.1.5. System parameters display .....	53
9.4.1.6. System coordinates display .....	54
9.4.1.7. Zoom function [key 1].....	54
9.4.1.8. Return [key 2].....	54
9.4.1.9. Dry run [X].....	55
9.4.1.10. Speed [Y] .....	55
9.4.2. Auto processing menu [MAIN MENU → F1 (AUTO)] .....	55
9.4.2.1. Pierce point [F1 (SECTION)] .....	55
9.4.2.2. Manual mode [F2 (MANUAL)] .....	55
9.4.2.3. Break point [F3 (BRK)].....	55
9.4.2.4. Preview [F4].....	56
9.4.2.5. Kerf [F5].....	56
9.4.2.6. More [F6].....	56
9.4.2.6.1. Outline [F1].....	57
9.4.2.6.2. Rotate (re-orientation) [F3] .....	57
9.4.2.6.2.1. Re-orientation angle processing .....	57
9.4.2.6.3. Mirror [F4].....	58
9.4.2.6.4. Scale [F5].....	58
9.4.2.6.5. Nest [F6].....	58
9.4.2.6.6. Tabbng - bridge function [F7 BREAK] .....	59
9.4.2.7. Return [F7].....	59
9.5. Automatic program mode.....	59
9.5.1. Cutting speed .....	60
9.5.2. Process start point .....	60
9.5.3. Active key functions when running a program.....	60
9.5.4. Active key functions in pause mode .....	61
9.5.5. Select program .....	63
9.5.6. Edge start cutting .....	63

9. 6. Manual mode .....	64
9.6.1. Manually controlled functions .....	64
9.6.1.1. [↑] [↓] [←] [→] [UP] [DOWN] [LEFT] [RIGHT] directional control keys [G].....	65
9.6.1.2. Mode switching [F1] .....	65
9.6.1.3. Step [F2] .....	65
9.6.1.4. More [F3] .....	65
9.6.1.4.1. P-START [F3] a P-END [F4] .....	66
9.6.1.4.2. Coordinates settings [F5] .....	66
9.6.1.4.3. Origin [F7] .....	66
9.6.1.5. Mach-0 [F4] .....	66
9.6.1.6. Rapid [F5] .....	66
9.6.1.7. Prog-0 [F6] .....	66
9.6.1.8. Return [F7] .....	66
9.7. Editing function .....	67
9.7.1 Edit function .....	67
9.7.1.1. New [F1] .....	67
9.7.1.2. Load [F2] .....	67
9.7.1.3. Save [F3] .....	68
9.7.1.4. Del file [F4] .....	68
9.7.1.5. Del line [F5] .....	68
9.7.1.6. USB [F6] .....	68
9.7.1.7. View [F7] .....	68
9.8. Setup [F4 PARAMER] .....	68
9.8.1. Process definition - speed .....	68
9.8.2. Speed parameters [F1] .....	69
9.8.3. System parameters .....	70
9.8.4. OXY parameters .....	71
9.9. Plasma parameters .....	72
9.9.1. Control parameters .....	73
9.9.2. THC .....	75
9.9.3. Save [F7] .....	75
9.9.4. Gallery function .....	76
9.9.5. Graphics library .....	76
9.9.6. Graphics library (shape development) .....	76
9.9.7. Shape check .....	76
9.9.7.1. Inside diameter cut [F1] and [F2] Outside diameter cut .....	77
9.9.8. Graphics library (nest function) .....	77
9.10. Program function .....	78
9.10.1. CNC program symbols (G - codes) .....	78
9.10.2. File types .....	79
9.10.3. File names .....	79
9.10.4. Units of measurement .....	79
9.10.5. Programming .....	79



---

9.10.6. System axes .....	79
9.10.7. G-codes .....	80
9.10.8. G92 - program zero point.....	80
9.10.9. G90 - absolute commands .....	80
9.10.10. G91 - incremental commands .....	80
9.10.11. G20 - imperial mode .....	80
9.10.12. G21 - metric mode .....	80
9.10.13. G00 - rapid travel.....	81
9.10.14. G01 - linear interpolation (motion in a straight line) .....	81
9.10.15. G02- G03 - circular interpolation (motion along a circular arc).....	81
9.10.16. G04 - pause/dwell .....	81
9.10.17. G40 - kerf off (compensation factor).....	81
9.10.18. G41 - kerf left .....	81
9.10.19. G42 - kerf right.....	82
9.10.20. G28 - return to reference point (zero position).....	82
9.10.21. G22 / G80 - cycle command (loop function) .....	82
9.11. M - codes.....	82
9.11.1. M00 - stop .....	82
9.11.2. M02 - program end .....	82
9.11.3. M07 - cutting sequence start .....	82
9.11.4. M08 - cutting sequence stop .....	83
9.11.5. Additional M-codes .....	83

## 9.1. Control panel functions



1. Display
2. Input keys
3. Menu / Function keys
4. Start button
5. Stop button
6. Software update button
7. USB / Dongle port

**Note:**

USB port has low power for file transfer only. Not for telephone charging.

## 9.2. CNC system functions

1. Versatile CNC cutting system, suitable for use with oxy fuel and plasma cutting processes.
2. The system is reliable and protected against electrical interference from plasma cutting and fluctuation in the power input.
3. Automatic height control and change of direction speed control, built-in kerf compensation and monitoring.
4. "AVC" Arc Voltage Control, maintains correct torch to work piece distance during plasma arc cutting process.
5. No loss of program data through sudden power loss, re-start at last position.
6. Dry run/trace capability, shape check and workpiece alignment/fit up.
7. Quick program access to any line or pierce/start point in a single or nested program.
8. Suited for use in a wide variety of applications in the metalworking industry.
9. Internal library of 50 pre-programmed customizable patterns/shapes.
10. STARCAM nesting software and FASTCAM nesting software are fully compatible. Interface conversion, in both English and Chinese language, customizable to other languages.
11. Dynamic graphic display, 1 to 8x zoom, automatically follows torch position.
12. USB port for loading software, updates and CNC programs.

**NOT to be used for CHARGING PURPOSES.**

## CNC System Technical Specification

Processor	ARM processing chip
Display	7" Color LCD, 800 x 480 resolution
Input/output	13 - 16 photoelectric isolation input, 8-way photoelectric isolation output, including four-way relay output
CNC Controlled Axes	X, Y and S (Vertical) with Height Controller
Top speed	< 3000mm/min.
Pulse equivalent	Flexible adjustment
Operating temperature	0 to +40°C; storage temperature: -30 to +60° C
Storage space	4Gb super program storage capacity

### 9.3. System main menu

#### 9.3.1. Menu features

The Graphic User Interface utilizes F-Function Keys, displayed at the bottom of the screen. The function keys [F1] to [F7] give the operator access to the system control functions. Press "ESC" to return to previous menu level.

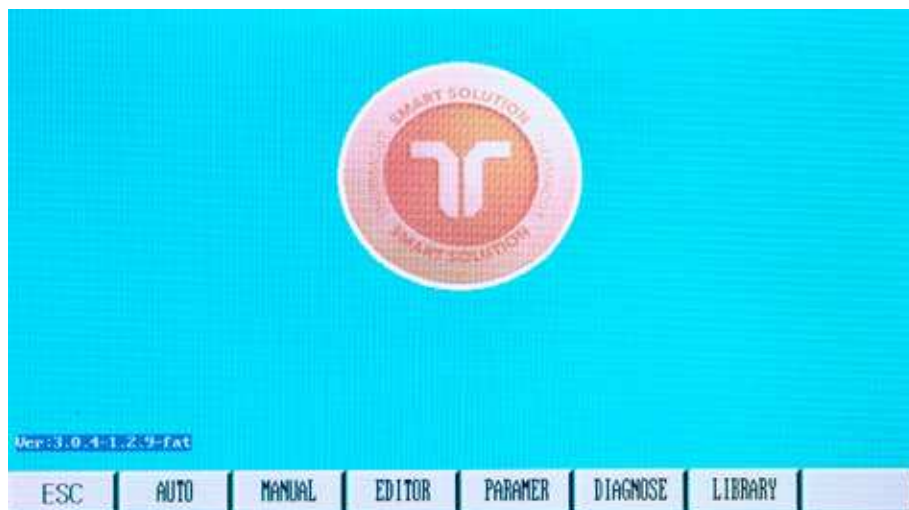

### 9.3.2. Main function F-key menu

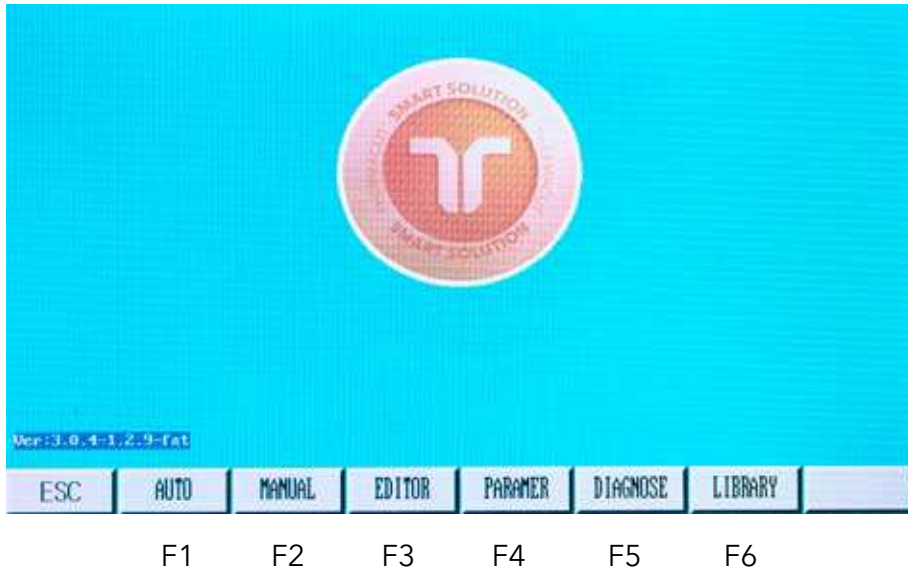

[F1] AUTO: Automatic CNC process control.

[F2] MANUAL: Manually position the cutting torch.

[F3] EDITOR: Edit/modify/USB input/USB output processing program.

[F4] PARAMER: System parameter settings.

[F5] DIAGNOSE: Check machine input and output information.

[F6] LIBRARY: Access standard graphic shapes and settings.

Software Version appears on lower left corner of screen.

### 9.4. Automatic function



## 9.4.1. Interfaces and inputs

### 9.4.1.1. Speed

In automatic mode: left upper corner of the screen shows F % (automatic processing speed/feed rate, the actual cut speed is calculated by taking the maximum cut speed and multiplying it by the feed rate.

In manual mode: left upper corner of the screen shows F %, the manual traverse feed rate as a percentage of max traverse, the actual speed is calculated by taking the maximum speed and multiplying it by the feed rate.

#### Speed

This shows the actual value, the feed rate is controlled by the use of [F↑] [F↓] keys.

Press [F] feed rate speed setting directly on the screen, and press [enter] to confirm.

Note: the speed shown in the display can be in Metric or Inch increments, changes can be made in Setting-Parameters-Control, Metric/Inch option.

### 9.4.1.2. Prog, pierce, kerf



As displayed at the top of the screen, PROG shows the title of the actual program being run. PIERCE shows the actual completed number of pierces in a running program. KERF shows the kerf offset input value.

### 9.4.1.3. Work mode - running status



Work mode bar shows: the current work status, CONTOUR, ROTATE, MIRROR, SCALE, NEST or BRAKE. Operational information bar indicates: machine activity or stopped, various system limit alarms and dwell period.

### 9.4.1.4. Input and output signals



The EX-TRACK® CNC System utilizes 8 input and 8 output ports. The display shows visual signals indicating the status of each input and output. The Input/output port is used for system diagnostics.

### 9.4.1.5. System parameters display

Indicates current parameter values.



### 9.4.1.6. System coordinates display

The coordinates displayed can be in Metric (mm) or Imperial (inches), to switch between settings: See, Parameters-Control.

**The CNC/Operator panel input keys are used to control the functions below.**

[IGNITION] - Ignition function see M code M20

[PREHEAT] - open oxygen solenoid valve, See M code M24

[GAS] - open acetylene gas solenoid valve, See M code M10

[CUTOXY] - open cutting oxygen solenoid valve, See M code M12.

[PIERCE] - pierce process control key, see M codes M71, M72, M73

**The oxy fuel piercing process:**

TORCHUP time - M70 timed process for raising torch at the start of the oxy fuel cut.

TORCHDN time - M71 timed process for lowering torch at the start of the oxy fuel cut.

PIERCEUP HIGH - M72 timed process for raising the torch at the start of the piercing.

PIERCEDN HIGH - M73 timed process for lowering the torch after piercing.

**Plasma cutting process:**

M07 starts the plasma cutting process.

M08 stops the plasma cutting process.

[S↑] - TORCH UP.

[S↓] - TORCH DOWN.

### 9.4.1.7. Zoom function [key 1]

The zoom function is used to closely view the profile part cutting path. Press the [1] key to magnify the part Image, press up to 3x for a maximum 8x magnification.

### 9.4.1.8. Return [key 2]

Returns image to original format.

#### **9.4.1.9. Dry run [X]**

Press the X-Key to initiate the Dry Run function, this allows the operator to check the exact programmed torch path, the torch is not "Live" during this process. Pressing the X-Key again will cancel the dry run.

#### **9.4.1.10. Speed [Y]**

The speed function indicates the actual speed in Metric/Inch. The Feed ratio can be manually adjusted using the [F↑] and [F↓] keys.

The speed can be manually entered, press the [F] key in the screen, at the top of the screen there is an input option for a numerical value to be entered using the keypad.

### **9.4.2. Auto processing menu [MAIN MENU → F1 (AUTO)]**

A cutting program can be generated in the Library or inputting it in the Edit mode. A chosen program can be initiated in the Auto mode. The system can run programs directly from the USB stick, programs do not need loading into the systems memory.

#### **9.4.2.1. Pierce point [F1 (SECTION)]**

The Pierce Point function permits the operator to pick a pierce point from where the cutting process can be re-started. Using function [F5], the operator can input the number of the chosen pierce point. This function allows the operator to select a pierce point at which to re-start cutting. Pressing the [ENTER] key, the system will automatically locate to the chosen pierce point and stop, this will enable the process to be re-started.

#### **9.4.2.2. Manual mode [F2 (MANUAL)]**

The manual mode allows operator defined input and control.

#### **9.4.2.3. Break point [F3 (BRK)]**

By pressing the [START] Key, the system re-loads the last incomplete program, the on-screen image shows a green cursor at the point where the program stopped. When the Break point is located, the Mode/Status changes from Break/Auto to Break/Break.

### 9.4.2.4. Preview [F4]

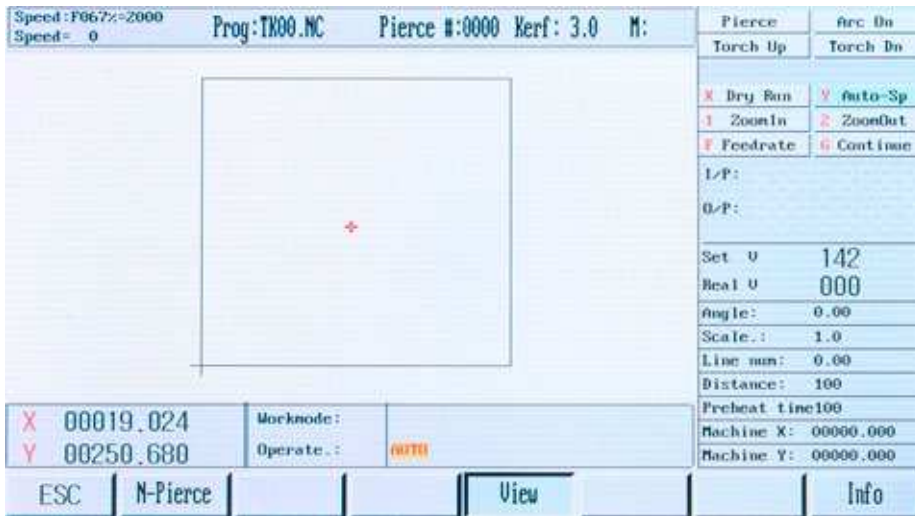

The on-screen graphics use a cursor to show a profile part or nest of profile parts to be cut, the cutting path of the torch and the completed cut area.

Press [1] key to magnify the profile part image, press up to 3x for a maximum 8x magnification.

Press [2] Returns image to original format.

### 9.4.2.5. Kerf [F5]

Use this function to enter a kerf compensation value, use the keypad to enter the value. Where a kerf value is not required, a "0" value can be entered.

### 9.4.2.6. More [F6]

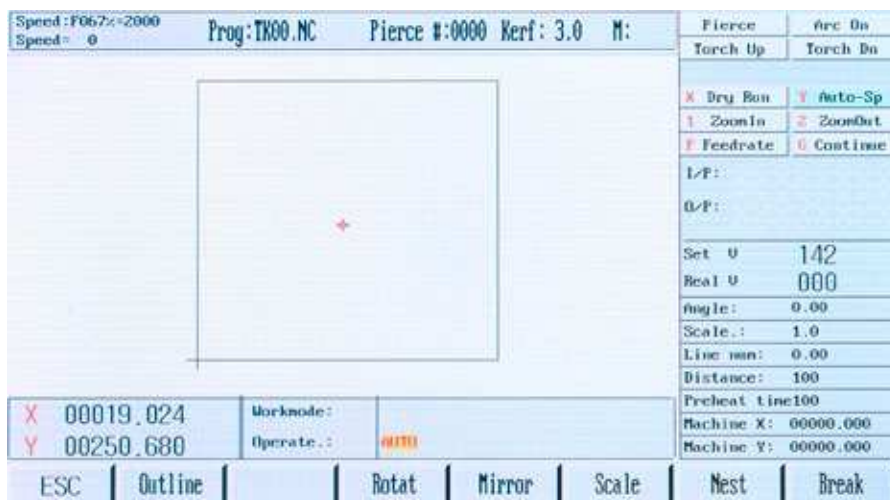

Pressing the [F6] key gives access to the sub-level programming in the Auto Mode menu.



### **9.4.2.6.1. Outline [F1]**

The OUTLINE function is used to confirm the fit of a programmed profile part or nest on to a plate. The system performs a rapid perimeter check in the form of a rectangle; the torch movement can be observed for its travel within the perimeter of the plate.

To activate the perimeter function, press key [F1], when the system is in the Program Zero position, the system will immediately start to move. When the system is not located at the Program Zero position, a screen prompt gives two options to pick from, choose START or ENTER.

**START FROM HERE** The torch will start tracing the program from the current position.

**FROM PROGRAM ZERO** The torch will return to the last fixed Program Zero position, the torch will start tracing the program from there.

When the torch is moving in the Perimeter mode, if the torch passes the over the perimeter of the plate, press [STOP], reposition the torch to within the perimeter of the plate, press [START].

A screen prompt in the Mode/Status section requires an input for REPOSITION-YES/NO. Press [ENTER] to confirm repositioning the program. Press [ESC] to cancel the move. This process can be performed as needed to make the program fit within the perimeter of the plate.

### **9.4.2.6.2. Rotate (re-orientation) [F3]**

The purpose of the ROTATE function is to enable the operator to re-orientate a profile part(s) to better fit the plate. The extent of re-orientation is determined by the operator, the input values are in degrees.

Input the required value, press [ENTER], a screen prompt in the Mode/Status section shows ROTATE, the degree of re-orientation is shown on screen.

**Note:** An increased re-orientation angle generates a counterclockwise program motion.

#### **9.4.2.6.2.1. Re-orientation angle processing**

Press the [F3] key, an on-screen prompt in the Mode/Status section requires an input angle value.

Input the value, press [ENTER] the Mode/Status section will show ROTATE, the degree of re-orientation is shown on screen.

Press the [F4] key to verify the re-orientated program.

Returning to Auto Mode MORE [F6] menu, the re-orientation process can be stopped, press the [F3] key. The degree of re-orientation is logged in the system, the process can be repeated as required.

### 9.4.2.6.3. Mirror [F4]

This function lets the operator invert a profile part, creating an exact opposite hand duplicate.

Pressing the [F4] key in succession, the software scrolls through the options of:

MIRROR X/Y, use the X option to invert the image (Left/Right). Use the Y option to invert the image (Up/Down).

### 9.4.2.6.4. Scale [F5]

The SCALE function lets the operator increase or decrease the size of a programmed profile part. Press the [F5] key, the on-screen prompt requires an input value lesser or greater than the actual size of 1 to 1, 1.000 = 100%. Press the [F5] key to return to the Auto Mode MORE menu, the size input value will be logged for re-use, the value can also be reset to zero in this process.

### 9.4.2.6.5. Nest [F6]

When using the Nest function, a profile part or multiple parts can be nested using the system software. The feature uses columns and rows to optimize the positioning of the parts. The process requires a program to be generated prior to the nesting process. Press [F6] to start the process.

Input the total number of rows (stacked format) and the total number of columns (aligned Left to Right). The system software automatically calculates the optimum spacing based on the profile part size. The Row-Offset feature optimizes the spacing of round or irregular shaped profile parts.

Upon completion of entering the input values, press [ENTER] the nest is then formed. The nest image is shown on the screen.

In the Mode/Status section, ARRAY is shown to indicate the formation of a nest from a profile part, the nest feature can be stopped when pressing the [F6] key in the Auto MORE menu.

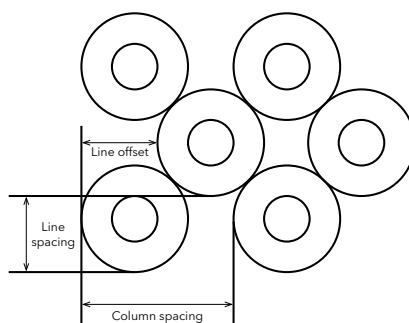

### 9.4.2.6.6. Tabbings - bridge function [F7 BREAK]

Creating tabs or bridge cutting, is performed by pre-determined stops in the cutting process, the size of tabs/bridges is dependent upon the profile part size, thickness and purpose of the tab/bridge. The process can be used to keep the profile part attached to the parent plate for a variety of purposes including minimizing the risk of the profile being distorted.

Pressing the [F7] key initiates the Tabbings/Bridge Mode, in the Mode/Status section, BRIDGE is shown, to stop the process, press [F7] in the Auto Mode MORE menu.

### 9.4.2.7. Return [F7]

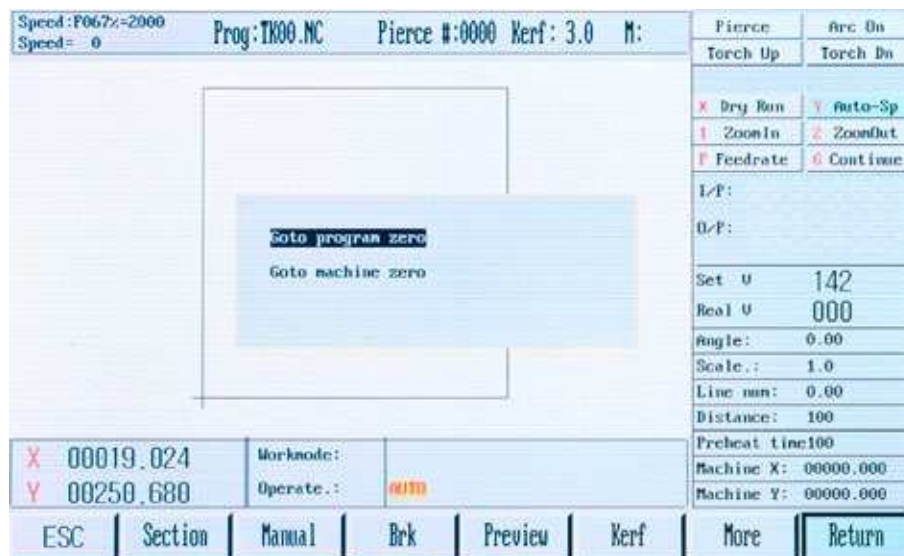

The RETURN function enables the system to quickly return to the ZERO point in a program or the system ZERO point. Press key [F7] to initiate the RETURN. The operator can choose the appropriate zero point.

## 9.5. Automatic program mode

The system requires a profile part or nest program to be entered, use one of the following methods.

1. Press the [ENTER] key, using the keypad, enter the program name, all programs must end with a (.) period/full stop. The system will search its file library for matching files of a .TXT/CNC format.
2. Using the USB port, programs can be accessed from the on-screen list.
3. New programs can be generated using the Shape Library. The library contains common shapes that can be altered dimensionally to produce a specified profile part.

### 9.5.1. Cutting speed

Prior to running a program, refer to the cut chart data for the process used, Oxy fuel/Plasma, material type and thickness, set the appropriate speed, then initiate the Auto Mode.

During the cutting process, the feed rate can be adjusted up/down by the [F↑] [F↓] keys, pressing the [F] key, a numerical value input can be made using the keypad. The input data is logged and can be retrieved.

### 9.5.2. Process start point

The torch is positioned on the plate at the start point of the cutting path, the Arrow keys are used to position the torch. Starting the program will reset the "X/Y" values to "0". There is no need to manually set the program zero position.

Pressing the GREEN [START] key will initiate the cutting process.

### 9.5.3. Active key functions when running a program

The active key functions available when running a program are limited to:

[F↑] [F↓] Feed Rate Increase/decrease, the incremental speed change is slow during the cutting process, giving greater control over the effect of speed change to the profile part. Making a significant speed change to the cutting process will require the process to be paused and input revised values.

[S↑] [S↓] Torch Up/Down, in the oxy fuel cutting mode, pressing Up/Down keys will increase/decrease the torch to work piece cutting height.

In the plasma cutting mode, the torch height is controlled automatically through the "AVC" Arc Voltage Control function. The torch height can be manually adjusted by pressing [S↑] [S↓] shortly after start-up to increase/decrease the torch to work piece height. The process will continue using the newest values, the values will remain as set until altered.

[G] Override Preheat Timer, using this function will cancel the preheat process and activate the oxygen cut flow gas. This action will not change the preheat timer settings.

[START] Cancel and Record Preheat Timer, pressing the [START] key when the preheat timer is functioning will cause the timer to stop, the cutting oxygen starts to flow, the piercing/cutting process begins. The actual preheat time is logged and used until altered.

[STOP] Preheat Timer Extend, pressing the preheat timer key during the preheat process, this increases the preheat process duration. The pierce process can be activated by pressing the [START] key, the timer will stop.

[STOP] Program Pause, pressing the [STOP] key during the cutting process, causes the system to ramp down to a halt, in the case of oxy fuel, the oxygen cut flow gas is switched off, in the case of plasma arc cutting, the arc is switched off. The on-screen status shows PAUSE, the pause menu follows.

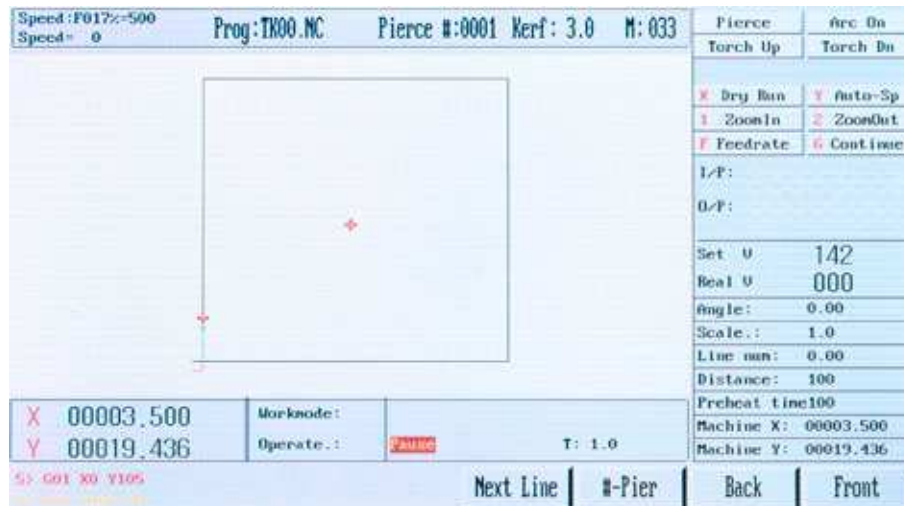

#### 9.5.4. Active key functions in pause mode

[START] Re-Start Program, after the pause period, press the [START] key to re-activate the process sequence. A mid-stream pause in the cutting process will require a manual re-start.

[Jog Keys] [↑] [↓] [←] [→], pausing the cutting process allows the torch to be positioned where consumable parts can be checked/changed, correcting the cut path or realign the plate. The torch moves at a preset rate.

[ESC] Park Program, using the [ESC] key during a pause period will result in the process being cancelled, the system will default to the Auto Mode Menu.

[F] Enter Feed Rate, using the [F] key, the speed rate may be altered, press the [F] key an on-screen prompt requires the actual feed rate, the input is made using the keypad.

[F] Feed Rate Increase/Decrease, using the [F↑] [F↓] will gradually increase or decrease the Feed Rate Override Percentage, this also affects the cutting speed. The value change rate is slower during the cutting process and quicker when the process is in the paused mode. To enable greater changes to the feed rate, put the process in to the paused mode and input the modified feed rate.

[S↑][S↓] Torch Up/Down, the [S↑][S↓] keys are used to raise and lower the torch.

[CUTOXY] Re-Start, use this key to manually restart the cutting process.

[PIERCE] Re-Start, use this key to start the pierce process, the process defaults to Auto Mode, the system starts moving at a pre-determined time.

[F↑][F↓][F] Keys can be used during the cutting process to alter the speed.

Pause Mode, an on-screen prompt requires the operator to make the appropriate speed adjustment.

Speed Selection, [↑][↓] Up/Down keys option, re-positioning/cutting speed in Manual/Automatic mode, select then [ENTER].

[F4] NEXT LINE, the operator can choose to re-start the cutting sequence at any position in the program. In the NEXT LINE Mode, keys [F6][F7] are used for scrolling through the program sequence, when a start point is chosen, on-screen, a Red Cursor shows the new start position.

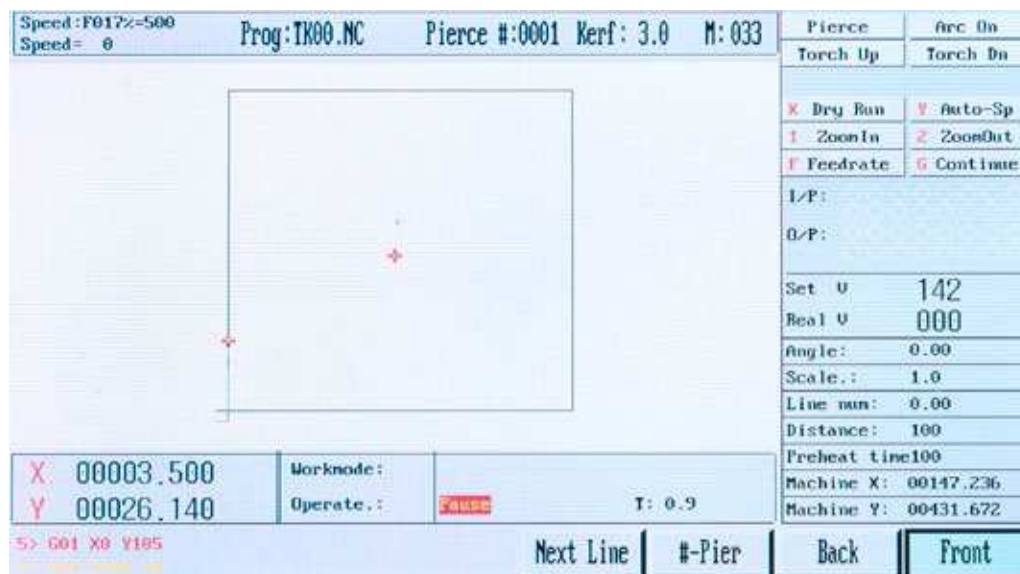

Pressing the [START] key, the torch will move to the new start position, the cutting sequence can then be re-started

[F5] #-PIER, When Paused, this feature lets the operator re-start the cutting sequence from a chosen position, an on-screen prompt requires the operator to input the pierce point. Press [ENTER], the torch travels to the pierce point, the cutting sequence can then be re-started.

[F6][F7] BACK/FRONT in the paused mode, using keys [F6]/[F7] the operator can move the torch

Backwards/Forwards through the cutting sequence at a pre-determined speed, press [STOP] when the torch is at the desired position or the on-screen ERROR CODE G00 is displayed. Pressing keys [F6] [F7] will override the error code.

Restart is used to reposition the torch after it has been moved off the cutting path to enable consumable change, new pierce point, dimensional part check or plate re-alignment. To re-start the cutting process, press [START], on-screen prompts require an input, the [↑] [↓] Up/Down keys to choose the required option and press [ENTER]

RETURN TO SEQUENCE with this function the operator can move the torch at speed to the last cutting point, a manual restart is required to initiate the cutting sequence. Pressing [START], the torch will move along the cut path, in the oxy fuel mode, pressing the [PREHEAT] key automatically causes the torch to move along the cut path after the relevant dwell period for piercing.

RESUME CUTTING this feature lets the operator resume cutting along the cut path after a break in the cutting sequence, a secondary pierce at the stop point, followed by a straight line cut to the point where the break in the cutting sequence occurred, the original cutting sequence is followed from this point.

STEP OVERRIDE this function will override the STEP process, reverting the process back to the cut sequence. Pressing [START] or [ENTER] initiates the function. The torch will travel along the cut path after pressing the [Start] key once more.

**Note:** When using the oxy fuel cutting process, ensure the Preheat procedure is followed prior to piercing or torch movement.

### **9.5.5. Select program**

This highly flexible system software lets the operator choose a cutting sequence start point from within a program. To activate the process, press [F1] key in the Auto Mode Main Menu, an on-screen prompt requires a Program Line/Pierce Number input. Before starting a cutting sequence, the operator can view the actual pierce point positions, the torch can be positioned at the chosen pierce point, a green cursor is visible and up to 8x zoom can be used to verify the position.

### **9.5.6. Edge start cutting**

This is used to trim profile/plate edges; it is also used to cut within a profile that already has a drilled/pierced hole. Edge starting can be used to cut thick and thin material. The operator should ensure that the torch is positioned at the plate edge, in oxy fuel cutting, too great a distance from the plate edge will result in insufficient preheat, leading to cutting issues. Plasma arc cutting, too great a distance from the plate edge will cause the arc to be stretched, causing damage to

consumable parts and the parent material.

Use the Edge Start setting, input the value 1, initiate a cut sequence in Auto Mode, when the torch reaches the pierce point, an on-screen prompt requires a pierce number.

Pressing the [START]/[ENTER] key gives Pierce options:

HOLE HERE the pre-programmed cutting sequence pierces at this point.

MOVE HOLE POSITION this feature allows the operator to position the torch at the plate edge, initiate the cutting sequence at that point, the system will cut to the pierce point and resume cutting along the cut path.

NO HOLE this option is used when piercing is not required.

**Note:** With oxy-fuel cutting, remember to follow the full cutting cycle, ignition, preheat and cut.

## 9.6. Manual mode

The Manual Mode is accessed through the main menu by pressing the [F2] key.



### 9.6.1. Manually controlled functions

The system can be manually controlled and input values altered using the menu function keys. The screen content is the same as in the Auto Mode, with the default set to Manual. The manually input Feed Rate Override Percentage and resulting speed shown relate to the Manual Jog Speed.



### 9.6.1.1. [↑] [↓] [←] [→] [UP] [DOWN] [LEFT] [RIGHT] directional control keys [G]

The directional control keys are used to position the torch; the speed of travel is faster than the cut speed. Using the [G] key function allows the torch to move non-stop in the direction of the pressed arrow until the arrow is re-pressed to stop the travel, alternatively, pressing the [STOP] key ends the movement. Pressing a combination of arrow keys at the same time will cause the torch to move diagonally, the direction of travel can be changed by pressing an alternative arrow key.

### 9.6.1.2. Mode switching [F1]

The manual setting is used to reposition the torch or maneuver the system for material realignment. Switching from the Manual Mode to the Auto Mode in the 1st level of the menu using the [F1] function key, lets the operator work in the AUTO MODE.

### 9.6.1.3. Step [F2]

This function allows the system to be automatically moved along the "X" or "Y" axes to a pre-determined point. Pressing the [F2] key initiates the process, with a prompt for the distance input value. After pressing the [ENTER] key the new travel distance is displayed on screen. The speed of travel requires input, after pressing a directional arrow [↑] [↓] [←] [→], the system will travel in that direction for the preset distance. The travel can be interrupted by pressing the [STOP] key.

### 9.6.1.4. More [F3]

Pressing the [F3] key takes the operator to the 2<sup>nd</sup> level in the Manual Mode Menu.

Speed : F100: 3000		Prog: TK00.NC		Pierce #: 0001 Kerf: 3.0 M:		Pierce	Arc On
Speed: 0						Torch Up	Torch On
						X Dry Run	Y Auto-Sp
						I ZoomIn	Z ZoomOut
						F Feedrate	G Continue
						L/F:	
						O/F:	
						Set U	142
						Real U	000
						Angle:	0.00
						Scale.:	1.0
						Line num:	0.00
						Distance:	100
						Preheat time: 100	
						Machine X: 00147.236	
						Machine Y: 00431.672	
X	00003.500	Worknode:					
Y	00026.140	Operate:	750000				
ESC			P-start	P-end	Coordi		Origin

#### **9.6.1.4.1. P-START [F3] a P-END [F4]**

This feature lets the operator check the alignment trueness of the plate to the system. The torch is moved to two positions along the nearest edge of the plate, the system software compensates for the out of true orientation of the plate. To activate the process, move the torch to position 1, press [F3] key then move the torch to position 2, press the [F4] key, the system will self-adjust to produce a true cut. The on-screen information shows ROTATE in the Mode Status section, the actual degree of offset is shown in the on-screen data.

#### **9.6.1.4.2. Coordinates settings [F5]**

Use key [F5] to access the coordinates settings function, scroll up/down and then [ENTER] for the chosen option.

**Zero all coordinates** - This resets ALL "X" and "Y" system and program coordinates back to zero.

**Setup coordinates** - With this function the operator can input new program coordinates, the X and Y values can be input in the Mode/Status section. Press [ENTER] for the values to be stored.

**Setup reference** - Clears the settings of the program coordinates. The X and Y values for program coordinates are set to zero at the current machine position.

#### **9.6.1.4.3. Origin [F7]**

This key allows to go back to manual mode menu.

#### **9.6.1.5. Mach-0 [F4]**

Pressing the [F4] key will zero the "X" and "Y" coordinate values in the system.

#### **9.6.1.6. Rapid [F5]**

The [F5] key is used to input a Feed Rate Override Ratio from 80% to 10%.

#### **9.6.1.7. Prog-0 [F6]**

Press [F6] key to zero the "X" and "Y" coordinate values at the actual stop point.

#### **9.6.1.8. Return [F7]**

Pressing the [F7] key will generate an on-screen prompt to speedily move the system back to its zero point or the program sequence zero point. Pressing the [START] - [ENTER] key accepts the chosen zero point; the system moves to that position.

## 9.7. Editing function

In the system main menu press [F3 EDITOR] to enter the Editing Menu. See the image below.



### 9.7.1 Edit function

#### 9.7.1.1. New [F1]

Use this feature to create a new file that can be edited, using the keypad, manually enter the program code.

#### 9.7.1.2. Load [F2]

Use this function to insert a program into the live program memory, the program is shown in the program editor and can be accessed in the Auto Mode. Pressing the [F2] key shows the stored programs in the memory. Scroll through the stored programs, press the [F7] key to PREVIEW the on-screen image of the chosen program, press [ESC] to delete and [Enter] to store in the program editor.



### **9.7.1.3. Save [F3]**

Edited programs can be saved in the memory, they can be renamed using the keypad, a maximum of 12 characters can be used to name a file. Press [ENTER] to save changes and [ESC] to leave without change.

### **9.7.1.4. Del file [F4]**

Press [F4], for an on-screen list of files stored in the systems memory, to remove a file press the [ENTER] key.

### **9.7.1.5. Del line [F5]**

Press [F5] to delete a line of input within a program.

### **9.7.1.6. USB [F6]**

Using a USB memory stick, program files can be uploaded to the program editor function, press [F1] to display the available programs. Press [ENTER] to download the file into the Editor. Run the program in the Auto Mode, press [F3] to name and store in the systems memory. The USB memory stick can be used to upload programs for storage or transfer in the OUTPUT mode, press [F2] to store the data.

### **9.7.1.7. View [F7]**

Lets the operator see an on-screen image of the program, accessed through the LOAD function in the program memory or USB stick.

## **9.8. Setup [F4 PARAMER]**

### **9.8.1. Process definition - speed**

For adjustment to all speed related settings. SYST: process/tolerance adjustment and control, software upper/lower limits. OXY: parameter settings for oxy fuel preheat and cutting. PLASMA: parameter settings for plasma pierce/cutting and Arc Voltage Control. CONTROL: process control options e.g. Plasma-Flame/Inch-Metric. The actual list of parameters exceeds what is displayed on the first screen, scroll to reveal more, using the keypad, input new values. Press the [F7] key to accept the changes, if they are not saved prior to pressing the [ESC] key, they will be deleted.

## 9.8.2. Speed parameters [F1]

The speed parameters are accessed in the SETUP menu by pressing the [F1] key.

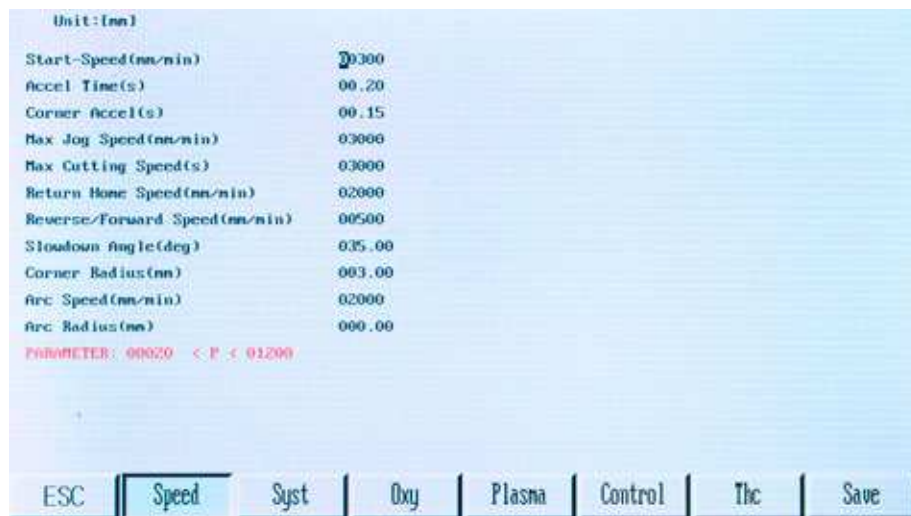

Unit: (mm)	
Start-Speed(mm/min)	0300
Accel Time(s)	00.20
Corner Accel(s)	00.15
Max Jog Speed(mm/min)	03000
Max Cutting Speed(s)	03000
Return Home Speed(mm/min)	02000
Reverse/Forward Speed(mm/min)	00500
Slowdown Angle(deg)	035.00
Corner Radius(mm)	003.00
arc Speed(mm/min)	02000
arc Radius(mm)	000.00
PARAMETER: 00020 < P < 01200	

**START-SPEED:** start up speed of the "X"- "Y" drive motors prior to reaching full speed, a lower speed causes less backlash when starting and stopping. Speed values are shown in Metric-mm/min or Imperial- inches/min.

**ACCEL TIME(S):** the acceleration time is measured in seconds; this time is used to measure the ramp up speed time from start to the set cut speed.

**CORNER ACCEL(S):** this is the adjusted ramp down/up speed at corners/change of direction.

**MAX JOG SPEED:** this is the maximum speed the system will travel in the Manual Step Mode and repositioning when in a program. " Program command G00 in mm/min or inch/min "

**MAX CUTTING SPEED(S):** fastest preset speed in a live cutting program, measured in mm/min or inch/min.

**RETURN HOME SPEED:** speed at which the system returns to the home point, measured in mm/min or inch/min

**REVERSE/FORWARD SPEED:** in automatic mode, after pausing, the backward/forward speed when on a cut path, measured in mm/min or inch/min.

**SLOWDOWN ANGLE:** angle below which CNC will decelerate for cornering.

**CORNER RADIUS:** radius to execute at corners in order to blend motion.

ARC SPEED: speed for cutting holes with radius smaller than Small Hole Radius.

ARC RADIUS: holes with a radius smaller than this will be cut at Small Hole Speed.

### 9.8.3. System parameters

The system parameters are accessed in the SETUP menu by pressing the [F2] key.

**WARNING:** Do not change the parameters below - except SOFT LIMIT parameters. Pre-adjusted from the factory!

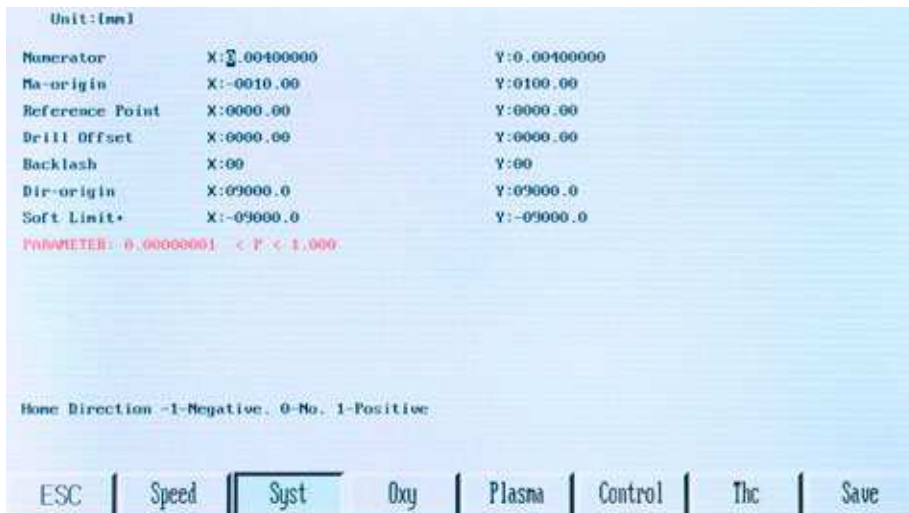

NUMERATOR: numerical analysis used for positioning accuracy.

MA ORIGIN: start point for the System Coordinates.

REFERENCE POINT: start point for the Program Coordinates.

DRILL OFFSETS: Function not used with EX-TRACK® CNC SYSTEM.

BACKLASH: Function not used with EX-TRACK® CNC SYSTEM.

DIR-ORIGIN: travel direction when the system returns to the start point.

SOFT LIMIT+: Software controlled limit in + direction. Maximal + length of the movement (cutting area limitation). For activation SOFT LIMIT function go to CONTROL menu and set: SOFTWARE LIMITS EF - „1“.

## 9.8.4. OXY parameters

The flame parameters are accessed in the SETUP menu by pressing the [F3] key.

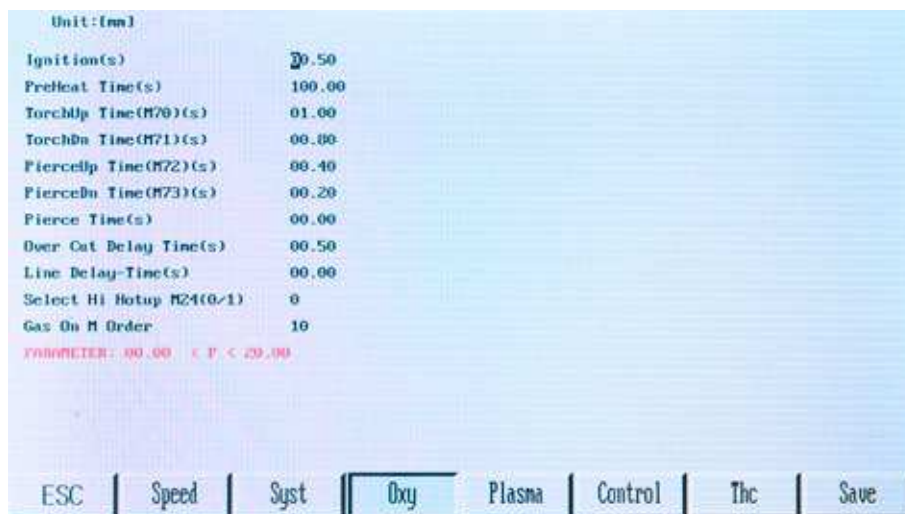

Unit: (mm)	
Ignition(s)	09.50
Preheat Time(s)	100.00
TorchUp Time(M70)(s)	01.00
TorchDn Time(M71)(s)	00.00
PierceUp Time(M72)(s)	00.40
PierceDn Time(M73)(s)	00.20
Pierce Time(s)	00.00
Over Cut Delay Time(s)	00.50
Line Delay-Time(s)	00.00
Select Hi Hotup M24(0/1)	0
Gas On M Order	10
PARAMETER: 00.00 < P < 29.00	

Navigation bar: ESC | Speed | Syst | **Oxy** | Plasma | Control | Thc | Save

**IGNITION:** Initial ignition height in secs (time of movement of the torch from this height to touching the plate).

**PREHEAT TIME:** Input a maximum preheat dwell period to suit the plate thickness prior to introducing the cutting oxygen.

**TORCHUP TIME (M70):** It is a time of the torch movement up (in sec.) from the cutting height to height for manual ignition of the flame.

**TORCHDN TIME (M71):** Is a time of the torch movement down (in sec.) from TORCH UP height to cutting height. After this action the preheat is running.

**PIERCEUP TIME (M72):** Timer used to raise the torch at the start of the piercing process.

**PIERCEDN TIME (M73)** Timer used to lower the torch at end of the piercing process.

**PIERCE TIME:** Time between actuating the cutting oxygen solenoid valve and starting the cutting motion. A longer dwell period is required for thicker material (like piercing delay time in plasma settings).

**OVER CUT DELAY-TIME:** Timed dwell period at the finish of a cut, cut oxygen pressure is reduced to prevent damage to a profile part.

**LINE DELAY-TIME:** Use this function for big thicknesses - set this delay time for cutting in the corners or when the torch change the direction

SELECT HI HOTUP M24 (0/1): Function not used with EX-TRACK® CNC SYSTEM.

GAS ON M ORDER: Function not used with EX-TRACK® CNC SYSTEM.

## 9.9. Plasma parameters

The plasma parameters are accessed in the SETUP menu by pressing the [F4] key.

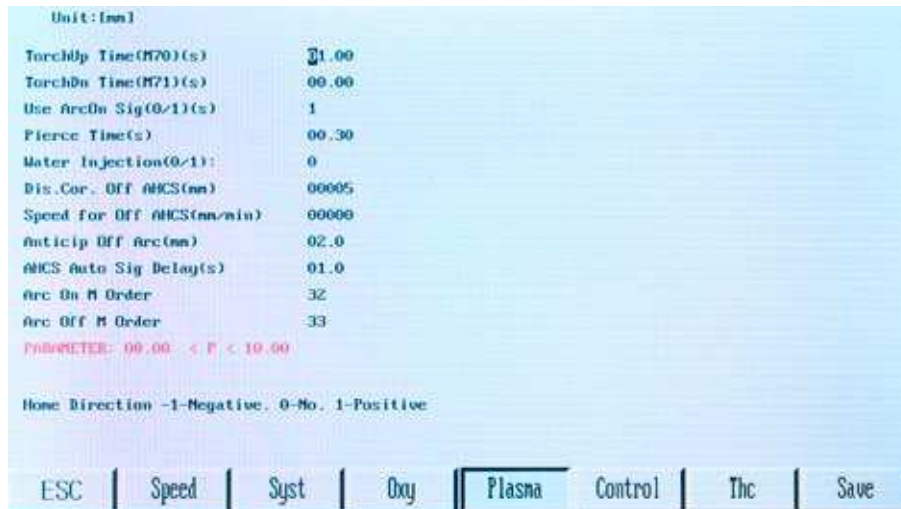

TORCHUP TIME (M70): torch retracts for short period prior to starting the IHS sequence.

TORCHDN TIME (M71): timer used to lower the torch at the end of the pierce sequence.

USE ARC-ON SIGNAL: receive arc-on signal from the plasma power supply prior to activating travel.

PIERCE TIME: travel dwell period after arc-on signal is received, starts plasma piercing sequence. Dwell period to suit material thickness.

WATER INJECTION (0/1): while the main arc on, the water cooler cycle on: This function for water cooler torch NOT USED here.

DIS.COR OFF AHCS: the corner distance to shut off the height controller: while the torch running the corner to set distance, the height controller will be shut off.

SPEED FOR OFF AHCS: the speed to shut off the height controller: The cutting speed low than this set parameter, the height controller will be shut off. This function main for cutting small hole.

ANTICIP OFF ARC - distance in mm in front of corner and behind the corner, when the THC will be turned off. For better cut quality of the corners.



AHCS AUTO SIG DELAY - Delay after cutting starts. Time needed for stabilizing the arc. After this time THC will start.

ARC ON M ORDER - Internal M-Code Order. Must be set to 32. Do not change.

ARC OFF M ORDER - Internal M-Code Order. Must be set to 33. Do not change.

### 9.9.1. Control parameters

The control parameters are accessed in the SETUP menu by pressing the [F5] key. Use [↓] for more parameters.

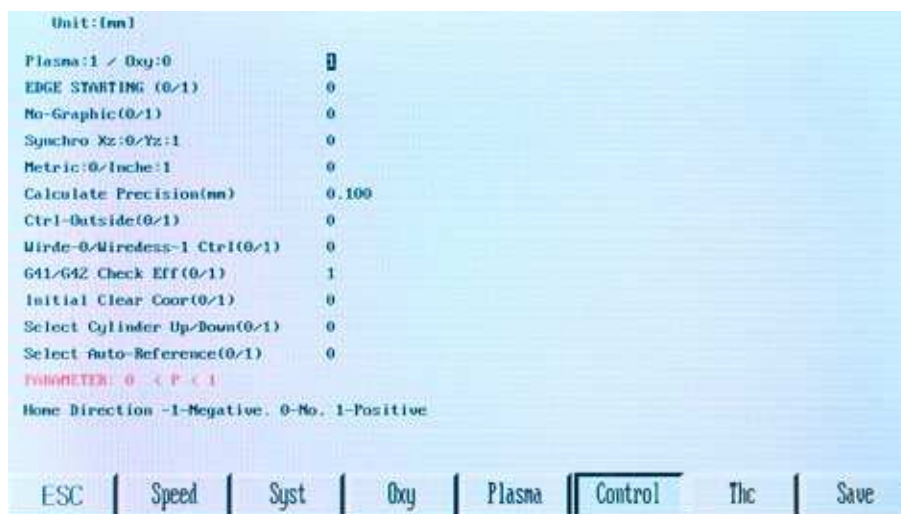

\*PLASMA:1 / OXY:0: in Auto/MANUAL Modes, select 0 for oxy fuel and 1 for plasma.

\*EDGE STARTING: is used to trim profile/plate edges; it is also used to cut within a profile that already has a drilled/pierced hole. Edge starting can be used to cut thick and thin material.

\*NO-GRAPHIC: in Auto Mode, stops on-screen display of the program parts, time is saved when cutting a large nest/program.

\*SYNCHRO XZ:0 / YZ:1: function not used with EX-TRACK® CNC SYSTEM.

\*METRIC:0 / INCH:1 : the system can be operated using Metric "0" or Inch "1" values, the system displays length/speed in the chosen value. The (G20)/mm (G21)/inch input code can be used to run programs in different formats.

\*CALCULATION PRECISION: the default value is 0.1mm. Consider decreasing this value to minimize the rounding up effect in the nesting program.

\*CTRL OUTSIDE: function not used with EX-TRACK® CNC SYSTEM.

\*WIRED/WIRELESS CTRL: function not used with EX-TRACK® CNC SYSTEM.

\*G41 /G42 CHECK EFFECT (0/1): check for kerf faults. No/0 ; Yes/1.

\*INITIAL CLEAR DOOR: program coordinates are automatically reset to zero when a program starts.

\*SELECT CYLINDER UP/DOWN: function not used with EX-TRACK® CNC SYSTEM.

\*SELECT AUTO-REFERENCE: torch can be automatically repositioned to the program zero point when the program ends. NO-"0" YES-"1".

\*LIMIT POSI EFFECT: activate position limits NO-"0" YES-"1".

\*SOFTWARE LIMITS EFFECT: activate software limits NO-"0" YES-"1".

\*CRASH DETECT: system/torch crash detection NO-"0" YES-"1".

\*CRASH DETECT NC:0 / NO:1: for plasma systems that use torch tip contact for Crash and IHS sensing.

\*CRASH PAUSE/TORCHUP: system pauses/torch lifts on crash detection.

\*TORCH UP ON PAUSE: torch lifts when program is paused.

\*CUTTING LINE: distance between bridge/tab points.

\*BRIDGE LENGTH: length of bridge/tab.

\*DISPLAY CO: do not change this parameter.

\*SHOW KERF: cutting in Auto Mode, display the kerf offset. YES-"0".

## 9.9.2. THC

The THC parameters are accessed in the SETUP menu by pressing the [F6] key.

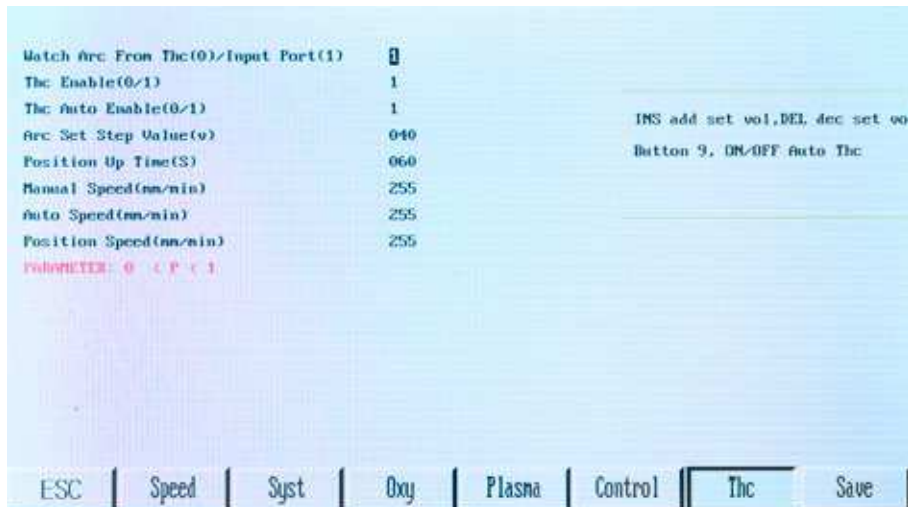

WATCH ARC FROM THC: " Ok to move" signal from THC or Plasma power source (arc transference signal).

THC ENABLE: enable automatic torch height control - 0 / off; 1 / on

THC AUTO ENABLE: automatic start and stop during cutting - 0 / off; 1 / on

ARC SET STEP VALUE: threshold when the THC will react for the change of cutting voltage - precision of the THC adjustment.

POSITION UP TIME: piercing and cutting height in seconds - time of lifting up the torch after IHS touch of the plate. Converting table between seconds and millimeters you can find on page 98.

MANUAL SPEED: the torch up/down speed for manual lift (up down manual speed).

AUTO SPEED: the torch up/down speed for automatic lift.

POSITION SPEED: the torch up/down speed for the initial position.

## 9.9.3. Save [F7]

This key save all adjusted parameters to the internal memory of EX-TRACK® unit.

### 9.9.4. Gallery function

The gallery function is accessed in the Main Menu by pressing [F6].

### 9.9.5. Graphics library

The library contains 50 geometrical shapes; the shapes can be dimensionally altered. The arrow keys [↑] [↓] [←] [→] are used to locate a shape, then [ENTER] to select. See Appendix for Shape Library Variables.

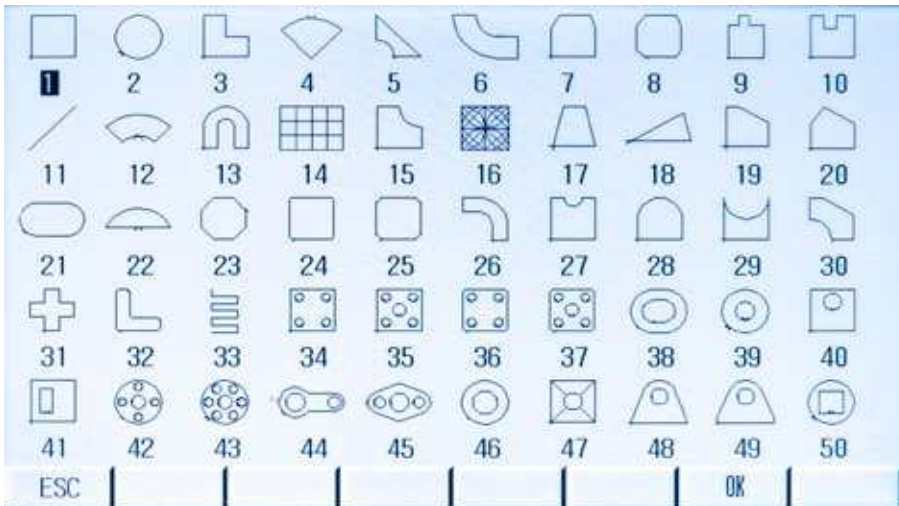

### 9.9.6. Graphics library (shape development)

Pick a shape from the graphics library, input the required dimensions into the Shape Evaluation Screen, nesting data can be added if needed. Validate all data/dimensional inputs using the [F6] OK key. By pressing the [ESC] key to exit the Shape Evaluation Screen, the shape is provisionally stored in the memory. Pressing the [F3] key initiates the EDITOR Mode, the new program is displayed in the edit screen. Press the [F7] VIEW key for showing the shape. Press the [F3] key for the SAVE function, input a program filename and save it to the program storage memory. The saved file can be started in the Auto Mode.

### 9.9.7. Shape check

This is used to verify that the input values for a shape are correct, input values are added by using the arrow keys [↑] [↓] and the [ENTER] key.



### 9.9.7.1. Inside diameter cut [F1] and [F2] Outside diameter cut

With this function an outside diameter cut can be made, this would normally be on a profile part that is wanted, it is possible to make an inside diameter cut, this is where the cut-out would normally be discarded.



### 9.9.8. Graphics library (nest function)

Input the required values for the number of rows and columns, the system software automatically

calculates the row height and column width relative to the part size, manual adjustment is permitted to improve the layout. The Row-Offset function may be used when a staggered fit gives better results. After the choosing the shape in graphic library and adjusting the dimensions, press the [ESC] key for access to main menu. Press [F1 AUTO] in main menu, press [F4 PREVIEW], press [ESC] , press [F6 MORE], press [F6 NEST].



Adjust the nesting parameters and press ENTER key.

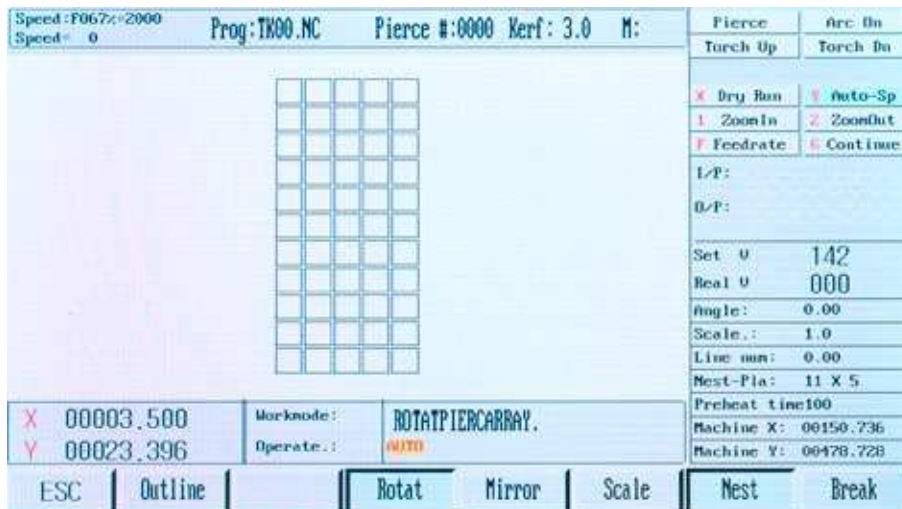

## 9.10. Program function

### 9.10.1. CNC program symbols (G - codes)

CNC systems require instructions that tell the drive motors where to move to, how fast to move and what path to follow. Programs are made up of lines of commands using G-codes with specific values.

#### LETTER - codes

- N - Numbering, can be used on all or just some lines, operator aid.
- G - Motion, rapid feed, circular feed or offset value.
- M - Machine Function, action code, auxiliary command.
- T - Tool Selection, used in this system for "Flame" value.
- L - Fixed Cycle Loop Count, tool offsets, radius offsets, length offsets etc.
- X - X-axis, absolute or incremental position of "X".
- Y - Y-axis, absolute or incremental position of "Y".
- I - Defines arc center in "X" axis.
- J - Defines arc center in "Y" axis.
- R - Defines the size of arc radius, may be used by replace I or J.
- H - Defines length offset.
- A - Absolute or incremental position of "A" axis.
- F - Defines feed rate, inches per minute/mm per minute used for G01, G02, G03.

## 9.10.2. File types

The ASCII file format is commonly used in the industry, a PC can be used to create/edit programs. Programs can be saved to a hard disk or copied to a USB stick.

## 9.10.3. File names

File names can be created within the system for easy recall, the file name is compiled using a maximum of 8 Name characters, a period/decimal point and 3 file type extension characters. The recognized file extension types are: "TXT" "CNC". The filename can contain alpha/numeric characters, preference is given to numeric only file names.

## 9.10.4. Units of measurement

The system can read program files generated in inch or metric increments, when a program is written using metric dimensions on a system that is setup for inch dimensions, the G-code G21 is written into the start of the program, for programs written in inches, the G-code G20 is written into the start of the program to convert to metric.

## 9.10.5. Programming

Programs can be generated in ABSOLUTE or INCREMENTAL modes, inputting code G90 at the start of a program, the system defaults to Absolute programming, by inputting the code G91 the system defaults to Incremental programming.

## 9.10.6. System axes

The system X-Y axes are shown below. The longitudinal guide rail represents the "Y" axis. The transverse guide rail represents the "X" axis.

### **9.10.7. G-codes**

Motion codes are used to define the systems programmed motions such as rapid feed, circular feed, offset value etc. The default of program input values is positive (+) therefore only a negative (-) value requires input when programming.

### **9.10.8. G92 - program zero point**

The G92 code is used to show the system where the absolute zero point is, it is usually followed by a X, Y and Z coordinate which is measured beforehand. If no X, Y value is input, the controller accepts the systems current position as absolute zero. It is important that the G92 code is read while the system is running, to ensure the system knows where the start point is. Every time the reset key is pressed, it clears the G92 value from the system memory.

**Format:** G92 Xn Yn

### **9.10.9. G90 - absolute commands**

The G90 code means that you are working from an absolute datum/zero point, every position or movement is a measurement from the datum. The G90 code must be used at the start of a program, the code remains active until changed.

**Format:** G90

### **9.10.10. G91 - incremental commands**

The G91 code means that you are working from the current position, inputting the movement X20, the system moves 20mm from the current position in a positive (+) direction. Each position is measured from the last one, the incremental distance moves irrespective of the current position. The G91 code must be used at the start of a program.

**Format:** G91

### **9.10.11. G20 - imperial mode**

The G20 code is associated with Imperial (Inch) dimensional program input to the controller. The G20 code must be used at the start of a program.

### **9.10.12. G21 - metric mode**

The G21 code is associated with Metric (mm) dimensional program input to the controller. The G21 code must be used at the start of the program.



### **9.10.13. G00 - rapid travel**

The G00 code is used for rapid travel between parts or positions in the program, it is also used for torch/consumable change/inspection, this action is performed at maximum speed.

**Format:** G00 Xn Yn.

### **9.10.14. G01 - linear interpolation (motion in a straight line)**

During interpolation commands the control will precisely and automatically calculate a series of very tiny single axis departures keeping the torch as close to the linear path as possible. The F command may be used to program the feed rate.

**Format:** G01 Xn Yn or G01 Xn Yn Fn.

### **9.10.15. G02- G03 - circular interpolation (motion along a circular arc)**

Circular interpolation requires the system to precisely coordinate two axes. G02 establishes a mode for clockwise circular arcs. G03 establishes a mode for counter-clockwise circular arcs. The center of an arc is identified by I, J or K to establish relative offsets from the starting point of the arc to the center. The code R may be used to replace I and J, R represents the radius of the arc, it is a positive value and can be used to give the radius of an arc up to 180°.

**Format:** G02[03] Xn Yn In Jn or G02[03] Xn Yn Rn.

### **9.10.16. G04 - pause/dwell**

This is the dwell command, it causes the system to stop for a specified length of time. The input value is L, in seconds.

**Format:** G04 Ln

### **9.10.17. G40 - kerf off (compensation factor)**

The G40 code cancels the Kerf compensation factor that is switched on by inputting G41 or G42. The system should be stationary when code changes are made.

### **9.10.18. G41 - kerf left**

This turns on the kerf compensation factor to the left of the cutting path.

### **9.10.19. G42 - kerf right**

This turns on the kerf compensation factor to the right of the cutting path.

**Note:** Enter command code G00 Rapid Positioning for a short distance so as to check the kerf compensation G41 G42 has been activated, the same process applies when cancelling the G40 function.

**Format:** G41 or: G42.

### **9.10.20. G28 - return to reference point (zero position)**

This function is used to return the torch to the systems reference position, also called zero position. The torch travels in the X - Y axes at the G00 maximum speed.

**Format:** G28 // Return to reference point.

### **9.10.21. G22 / G80 - cycle command (loop function)**

The G22 code is used to start a cycle, input values L show the number of cycles to be executed, G80 ends the cycle.

**Format:** G22 Ln // Loop for L cycles

## **9.11. M - codes**

### **9.11.1. M00 - stop**

The M00 code is used to create a stop point within a program, if the stop function is activated, the [START] key must be pressed to continue with the program.

### **9.11.2. M02 - program end**

The M02 code is used to stop an auto run or end a program, G02 needs to be in the last line of the program.

### **9.11.3. M07 - cutting sequence start**

The M07 code is used to start an automatic cutting sequence, with the following functions for oxy fuel and plasma. The sequence for oxy fuel cutting is: pauses system travel, starts preheat timer, turns on the cutting oxygen and starts the pierce timer, then system starts to travel. The sequence for plasma cutting is: pause system travel, implements height sensing function, plasma arc ignition.

Arc-on signal received, then system starts to travel.

#### **9.11.4. M08 - cutting sequence stop**

The M08 code is used to shut down the oxy fuel and plasma cutting processes, the sequence for oxy fuel cutting is: pauses system travel, shuts the cutting oxygen valve, starts the bleed down timer, pause is lifted so the system can travel. The sequence for plasma cutting is: pauses system travel, switches the plasma arc off, torch is raised, Arc-on signal received, pause is lifted so the system can travel.

#### **9.11.5. Additional M-codes**

M10 / M11 oxy fuel - fuel gas valve switch

M12 / M13 oxy fuel - cutting oxygen valve switch, M12 (open) M13 (off)

M14 / M15 cutting torch switch, M14 (open), M15 (off)

M16 / M17 cutting torch switch, M16 (open), M17 (closed)

M20 / M21 ignition switch, M20 (open), M21 (closed)

M24 / M25 standby switch, m2-m24 (open), the M25 (closed)

## SECTION 10.

### FAQ's Operating the system:

10.1. FAQ's Operating the system .....	85
10.2. Basic trouble shooting.....	87
10.3. Software service instructions - Boot menu .....	94
10.4. Backup and restore parameters .....	95
10.5. Changing System name text.....	97
10.6. Hardware service instructions.....	97
10.6.1. Replacing main fuse .....	97
10.6.2. Converting table for "Position Up Time" parameter.....	98

## 10.1. FAQ's Operating the system

**Q: How do you continue operation after a cutting stoppage during automatic cutting?**

A: The following functions can be used after cutting is stopped in the automatic mode:

[STOP] key: The system will stop. The program can be continued immediately by pressing [START] key. If necessary, use the arrow keys [↑] [↓] [←] [→] to adjust the torch position. When the torch is located at required position, press the [START] key to continue cutting.

Use the [F↑] [F↓] keys to adjust the speed up or down, by 1% for each button press.

Use the [S↑] [S↓] keys to move the torch up or down.

**Q: How do you restart a cut if the plate did not pierce?**

A: The system can be sent back to the origin if this happens. Press the [STOP] key to stop system motion, then press the [F6] key to move backwards on path. The torch will move backwards on path until it reaches the pierce point. You may then re-start the cutting process and press the [START] key to begin cutting again.

**Q: If the power is lost during cutting, or some other interruption causes the program to be abandoned, can the un-finished program be recovered?**

A: Yes, the operator can use RESUME function to finish cutting a parked program:

1. If the program has been stopped and abandoned manually, follow the procedures in section Resuming Parked Programs.

If there is a loss of power while cutting, the program can easily be recovered as long as the machine is not moved while power is off. Follow the procedures in section Resuming Parked Programs, but be sure to select the option 3) RELOCATE PATH, so that the program will continue from the current system position.

**Q: Why can some part program files not be read by the CNC after they are copied to the USB stick using Windows Explorer?**

A: If using the file type extension ".MPG", Windows can include meta-data in the file or on the disk. It is suggested that files only use the file type extensions ".CNC" or ".TXT" in order to avoid problems.

**Q: Why does the system lock-up when reading the USB stick?**



A: If the USB stick checks out OK, there may be two reasons:

1. There may be system or hidden files on the USB stick that the CNC is attempting to read. Some system files will cause the CNC to repeatedly attempt to read a file which cannot be understood by the CNC, so it appears to be locked up. It is suggested that the USB stick be freshly re-formatted, and only the necessary part programs be stored on it.

2. Inspect the USB socket to see if it may be loose, or if it may have become fouled with dirt or soot.

USB must be formatted according to original instructions. This CNC only supports FAT or FAT32 file systems. Format to FAT or FAT32.

## 10.2. Basic trouble shooting

 	<p style="text-align: center;"><b>WARNING!</b></p> <p>HIGH VOLTAGE is present inside this system, ONLY suitably qualified personnel should remove the cover for the purpose of Service or Repair. <b>ELECTRIC SHOCK CAN KILL!</b></p>
---	---

<b>Fault</b>	<b>This may mean</b>	<b>Cause</b>	<b>Solution</b>
<b>System won't move.</b>	<ul style="list-style-type: none"> <li>• Drive Power Indicator Lamp is ON - illuminating.</li> </ul>	<ul style="list-style-type: none"> <li>• Off Line pushbutton may be pressed.</li> <li>• Main power switch is OFF.</li> </ul>	<ul style="list-style-type: none"> <li>• Press Off Line pushbutton until it pops out.</li> <li>• Make sure, that main power switch is turned ON.</li> </ul>
<b>Torch lifter won't move up or down.</b>	<ul style="list-style-type: none"> <li>• Up and Down relays on CNC are activating.</li> <li>• Up and Down relays are not activating.</li> </ul>	<ul style="list-style-type: none"> <li>• Cable un-plugged or damaged.</li> <li>• Lift Motor or Micro Switch Failed.</li> <li>• 24 Volt Power may be missing.</li> </ul>	<ul style="list-style-type: none"> <li>• Check plugs and cables at both ends of Transverse rail. Check plug on Connector Panel on rear of Main Unit. Inspect cable for damage.</li> <li>• Check for 24 VDC at motor cable plug. Replace fuse, motor or Micro Switches if necessary.</li> <li>• Check output of 24 Volt Power Supply. Check 24 Volt fuse on left side panel. Replace if necessary.</li> <li>• Check connections to side of CNC unit.</li> </ul>

<b>Fault</b>	<b>This may mean</b>	<b>Cause</b>	<b>Solution</b>
<b>Initial Height Sensing does not work.</b>	<ul style="list-style-type: none"> <li>• Check the IHS cable plug on Connector Panel at side of Main Unit.</li> <li>• Check the pins positions and wires in both parts of IHS connector on the torch lifter.</li> <li>• Check connection of black ground wire to plate/ground.</li> <li>• Check connection of red torch wire at the shield cap.</li> </ul>	<ul style="list-style-type: none"> <li>• Plug may be loose or damaged.</li> <li>• Wires may be broken.</li> <li>• Connection may be loose or disconnected. Plate may not have sufficient electrical contact with table.</li> <li>• Connection may be loose or damaged.</li> </ul>	<ul style="list-style-type: none"> <li>• Tighten or repair plug.</li> <li>• Replace Cable.</li> <li>• Fix or tighten ground connection. Ground directly to the plate if necessary.</li> <li>• Fix or tighten torch shield connection.</li> </ul>
<b>System will not power on.</b>	<ul style="list-style-type: none"> <li>• Check Main Fuse.</li> </ul>	<ul style="list-style-type: none"> <li>• Fuse may be blown. See section 11.5.1 for fuse location and replacement.</li> </ul>	<ul style="list-style-type: none"> <li>• Replace fuse with the same type, voltage and amperage rating.</li> </ul>
<b>System starts moving before plasma fires.</b>	<ul style="list-style-type: none"> <li>• Check parameter settings.</li> </ul>	<ul style="list-style-type: none"> <li>• Parameter may be set incorrectly, or parameters may be corrupted.</li> </ul>	<ul style="list-style-type: none"> <li>• Make sure Plasma Parameter for "Use Arc On Signal" is set to 1 (ON).</li> </ul>



<b>Fault</b>	<b>This may mean</b>	<b>Cause</b>	<b>Solution</b>
<b>Parts come out wrong size.</b>	<ul style="list-style-type: none"> <li>• Check parameter settings.</li> <li>• Check Kerf setting.</li> <li>• Check Inch/Metric parameter.</li> </ul>	<ul style="list-style-type: none"> <li>• Parameters for Numerator and Denominator may have been changed.</li> <li>• Value for Kerf may be wrong.</li> <li>• Value may have been changed to incorrect setting.</li> </ul>	<ul style="list-style-type: none"> <li>• Make sure Numerator and Denominator settings are correct, as this will affect dimensional accuracy.</li> <li>• Set the correct Kerf value in the Auto Mode.</li> <li>• This setting will change all dimensions between inch and metric.</li> </ul>
<b>On-screen graphics look wrong.</b>	<ul style="list-style-type: none"> <li>• Check parameter settings.</li> </ul>	<ul style="list-style-type: none"> <li>• Parameter may be set incorrectly, or parameters may be corrupted.</li> </ul>	<ul style="list-style-type: none"> <li>• Make sure Control Parameter for Display Density is set to 0.</li> </ul>
<b>Graphics not shown while running a part.</b>	<ul style="list-style-type: none"> <li>• Check parameter settings.</li> </ul>	<ul style="list-style-type: none"> <li>• Parameter may be set incorrectly, or parameters may be corrupted.</li> </ul>	<ul style="list-style-type: none"> <li>• Make sure Control Parameter for No-Graphics is set to 0 (OFF).</li> </ul>
<b>System suddenly stops in the middle of normal cutting operations.</b>	<ul style="list-style-type: none"> <li>• Does it always stop at the same position in every program?</li> <li>• The CNC appears to be running, but the torch has stopped moving in one or both axes.</li> <li>• The CNC appears to be running but does not respond to manual the key panel or the Start or Stop keys.</li> </ul>	<ul style="list-style-type: none"> <li>• Part program may have problem.</li> <li>• Drive motor is jammed, or drive has failed.</li> <li>• The CNC may be "locked-up".</li> </ul>	<ul style="list-style-type: none"> <li>• Send the part program to the programmer or to THERMACUT for evaluation.</li> <li>• Make sure the System is level. Check the motors to make sure they are still functioning properly.</li> <li>• Make sure plasma system is properly grounded.</li> <li>• Check the incoming power line to ensure power is not being momentarily interrupted.</li> <li>• Remove power and re-boot the control.</li> </ul>

<b>Fault</b>	<b>This may mean</b>	<b>Cause</b>	<b>Solution</b>
<b>One of the motors does not turn.</b>	<ul style="list-style-type: none"> <li>• Check wiring from drive amp to motor.</li> <li>• Check the drive amplifier.</li> <li>• Check settings of SYSTEM parameters.</li> <li>• Check motor to make sure it is not frozen or jammed.</li> </ul>	<ul style="list-style-type: none"> <li>• Loose connection.</li> <li>• Check for any alarms or if the settings are not correct.</li> <li>• Check if Start Speed is zero or too high, the Acceleration Time is too short, or Numerator and Denominator settings are set incorrectly or set to zero.</li> <li>• Motor may be damaged.</li> </ul>	<ul style="list-style-type: none"> <li>• Secure all wiring connections.</li> <li>• Correct settings of drive amp.</li> <li>• Set the parameters to the appropriate settings. Be sure to record the original parameters before making any modification.</li> <li>• Replace motor if damaged.</li> </ul>
<b>CNC is slow to respond.</b>	<ul style="list-style-type: none"> <li>• Check the power supply.</li> <li>• Check settings of SYSTEM parameters.</li> </ul>	<ul style="list-style-type: none"> <li>• Output voltage may be below the allowable range.</li> <li>• Corrupt or incorrect parameters may cause CNC operating issues.</li> </ul>	<ul style="list-style-type: none"> <li>• Adjust the output voltage or replace the power supply.</li> <li>• Set the parameters to the appropriate settings. Reset to factory settings if necessary. Be sure to record the original parameters before making any modification.</li> </ul>
<b>Travel limit alarm at power-on.</b>	<ul style="list-style-type: none"> <li>• Check settings of SYSTEM parameters.</li> </ul>	<ul style="list-style-type: none"> <li>• Machine position may be outside settings for Soft Limits.</li> </ul>	<ul style="list-style-type: none"> <li>• Press Off Line button, manually move torch head to normal cut area, try to run again. Increase settings for Soft Limits if necessary.</li> </ul>

<b>Fault</b>	<b>This may mean</b>	<b>Cause</b>	<b>Solution</b>
<b>The system is locked up in Manual or Automatic mode.</b>	<ul style="list-style-type: none"><li>• Check settings of SYSTEM parameters.</li></ul>	<ul style="list-style-type: none"><li>• Incorrect parameter setting.</li></ul>	<ul style="list-style-type: none"><li>• Record the settings for Numerator and Denominator in the SYSTEM Parameters. Then reset the factory parameters. Reboot the system and then re-enter the recorded values for Numerator and Denominator. Save the parameters and test the system performance.</li></ul>
<b>No input/output.</b>	<ul style="list-style-type: none"><li>• Check the cables connected to the rear of the Central Unit.</li><li>• Check for low or missing 24V power. Check the voltage of 25-pin port between Pin 24 and Pin 25.</li><li>• Check all cable and wiring connection inside the Central Unit.</li></ul>	<ul style="list-style-type: none"><li>• Loose connection or broken wires.</li><li>• 24V Power Supply may have failed.</li><li>• Loose/broken connection.</li></ul>	<ul style="list-style-type: none"><li>• Secure the connection or replace cables as necessary.</li><li>• Adjust or replace the 24V Power Supply. Check 24V fuse on left side panel. Replace with same value if blown.</li><li>• Secure the connections or replace wires if necessary.</li></ul>

Fault	This may mean	Cause	Solution
<b>USB stick cannot be read</b>	<ul style="list-style-type: none"> <li>• Try a different brand of USB stick.</li> <li>• Check the file system format on the USB stick.</li> <li>• Check the USB port and USB stick connector for any accumulation of dust or soot.</li> <li>• Inspect condition of USB port and USB stick connector.</li> </ul>	<ul style="list-style-type: none"> <li>• The USB stick may not be compatible with this CNC.</li> <li>• The USB stick may be formatted incorrectly. This CNC only supports FAT or FAT32 file systems.</li> <li>• Metallic dust may short signals.</li> <li>• Damaged or broken pins/ contacts can disrupt operation.</li> </ul>	<ul style="list-style-type: none"> <li>• Use only a compatible USB stick.</li> <li>• Reformat the USB stick to FAT or FAT32 format using a PC.</li> <li>• With input power off, clean any foreign material from the USB port and the USB stick connector using non-conductive tool and vacuum. Keep cover closed over USB port.</li> <li>• Discard and replace any damaged USB stick. Replace the USB port if damaged.</li> </ul>
<b>The system returns to the main menu after a program is started.</b>	<ul style="list-style-type: none"> <li>• Select a different program and test the system.</li> </ul>	<ul style="list-style-type: none"> <li>• If the other programs will run, there is a problem with the original program.</li> <li>• If no program will run, there may be a problem with the parameter settings.</li> </ul>	<ul style="list-style-type: none"> <li>• Check the program.</li> <li>• Record the settings for Numerator and Denominator in the SYSTEM Parameters. Then reset the factory parameters. Reboot the system and then re-enter the recorded values for Numerator and Denominator. Save the parameters and test the system performance.</li> </ul>

Fault	This may mean	Cause	Solution
<b>The system will only cut a straight line, it will not cut a circle.</b>	<ul style="list-style-type: none"> <li>Select a different program and test the system.</li> </ul>	<ul style="list-style-type: none"> <li>If the other programs will run, there is a problem with the original program.</li> <li>If no program will run, there may be a problem with the parameter settings.</li> </ul>	<ul style="list-style-type: none"> <li>Check the program.</li> <li>Record the settings for Numerator and Denominator in the SYSTEM Parameters. Then reset the factory parameters. Reboot the system and then re-enter the recorded values for Numerator and Denominator. Save the parameters and test the system performance.</li> </ul>
<b>Screen blinks when the Cut Oxygen solenoid valve opens, or when plasma arc starts.</b>	<ul style="list-style-type: none"> <li>Check ground (Work/Table) connection of the Initial Height Sensing cable.</li> </ul>	<ul style="list-style-type: none"> <li>Electrical noise, loose ground connection.</li> </ul>	<ul style="list-style-type: none"> <li>Make sure ground connection is tight and is making good electrical contact. Make sure all cables are connected properly and are in good condition.</li> </ul>
<b>Outputs do not turn on when indicated on screen (Cut-Oxy Solenoid or Plasma Start).</b>	<ul style="list-style-type: none"> <li>Check 24 Volt power supply. Measure voltage between wires labelled 24V and 24G at the Main Power Supply.</li> <li>Check the six relays inside the CNC Unit.</li> </ul>	<ul style="list-style-type: none"> <li>If missing 24 Volts DC, power supply may have failed.</li> <li>Relay may be loose or un-seated in socket or may have failed.</li> </ul>	<ul style="list-style-type: none"> <li>Check and replace the Main Power Supply. Check 24V fuse first on left side panel. Replace with same value if blown. Check and replace the Main Power Supply if failed.</li> <li>Re-seat or replace relays. Disconnect input power. Remove cover. See section 8, figure 2.</li> </ul>

**WARNING!**

HIGH VOLTAGE is present inside this system, ONLY suitably qualified personnel should remove the cover for the purpose of Service or Repair. **ELECTRIC SHOCK CAN KILL!**

## 10.3. Software service instructions - Boot menu

There are three options within the Boot Menu for servicing the system. The Boot Menu is activated from the Main Menu. Press the [ESC] key repeatedly if required, to return to the Home Screen. Press sequentially keys [G] [G] [3] the Boot Menu will be shown as below.



Boot Menu has three options. The three options are:

### 1. Parameter

Load factory settings. This function erases all settings and drawings from the CNC unit.

### 2. File format

By this function you can erase all drawings which are saved in the CNC unit. CNC unit setting will remain.

### 3. Language

This option will hold the name of the alternate language that has been pre-loaded in the control. The control can be pre-loaded with two languages. As an example: For North America, those languages will be English and Spanish. Selecting this option will switch between the two.

## 10.4. Backup and restore parameters

All system parameters can be backed up to, or restored from, a USB stick. They can also be saved in to permanent memory as the factory settings, although that procedure is not recommended for use by end users.

To access this feature, go to the main menu in the PARAMER Window. Type the password '1928' on the number keypad. The following dialog will appear:



Parameter Backup Menu has three options. The three options are:

### 1. Save to factory setting

When this mode is selected, the [F7] key changes to show "FACTORY" in each of the Parameter Groups. All changes that are made will be saved as "Factory Settings" when the [F7] key is pressed.

### 2. Save parameters to USB

This option will store parameters to the USB stick. A USB stick must be inserted. When this option is highlighted, and then the [ENTER] key is pressed, a file named "PARA.DAT" is written to the USB stick.

### 3. Import parameters from USB

This option will read in a set of stored parameters from the USB stick. A USB stick must be inserted which has the file "PARA.DAT" present. When this option is highlighted, and then the [ENTER] key is pressed, the "PARA.DAT" file is read from the USB stick, and all parameters are overwritten.

The system firmware of controller can be updated through a USB stick. In case a system software update is supplied by THERMACUT and needs to be installed, carefully follow this procedure:

### **1. Copy the update file titled STARTCNC.EXE to a USB stick.**

1. The USB stick should be freshly formatted as FAT or FAT32 format. The STARTCNC.EXE file should be the only file on the USB stick.
2. Press and hold the Software Update button while the system power is switched on. Continue to hold the button until the upgrading window appears on the display screen.



3. Plug the USB stick into the port and press the [F1] key to select UPDATE. The system will automatically start the update operation.
4. If the update is successful, the system will display "PLEASE REBOOT", and sound two beeps. If the update fails, the system will display "UPDATE FAILED", and sound continuous beeps.
5. Power the system off and unplug the USB stick. Reboot the system to start up the updated system. The version number of the updated system software will appear on the screen after boot-up.

**Note:** If the update fails, check the following:

### **2. The USB stick must be FAT or FAT32 format. FAT is preferred.**

1. The update file must be named STARTCNC.EXE.

If no prompt appears in the updating process and the display returns to the main updating window or updating fails due to any other interruption, first verify the name of the update file and the USB formatting. If these two factors are confirmed, attempt the update again following the above procedure. If the update fails again, contact THERMACUT® Technical Support for assistance.



## 10.5. Changing System name text

System name information displayed on the main menu can be changed if necessary. The standard text is "THERMACUT THE CUTTING COMPANY", and "EX-TRACK® CNC", as shown below:

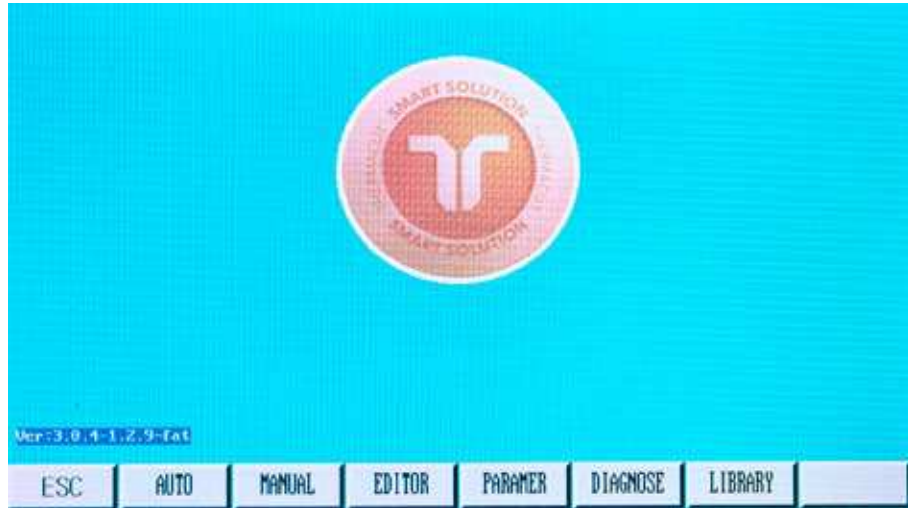

The desired text must be entered into a text file called "NAME.txt", to be supplied by THERMACUT®. Copy this file onto a USB stick, and insert into the USB port.

The following key sequence must be activated from the Main menu. Press the [ESC] key, repeatedly if necessary, to return to the Main menu.

Press these keys one after the other: [G] [G] [8]

A prompt will appear, asking you to press [ENTER] to confirm changing the Name Text, or [ESC] to abort changing the Name Text.

After pressing the [ENTER] key, the new text should appear on the main menu.

## 10.6. Hardware service instructions

### 10.6.1. Replacing main fuse

The main fuse can be found inside the main ON/OFF switch that is on the Left side panel of the main unit. Isolate the main unit by removing the power lead, to remove the fuse, use a small flat-head screwdriver, fit a new fuse of the same type and value, using a fuse of a higher value could cause serious damage to the system or injury to the operator.



Number	Description
1	Power switch
2	Main power fuse
3	Power connector

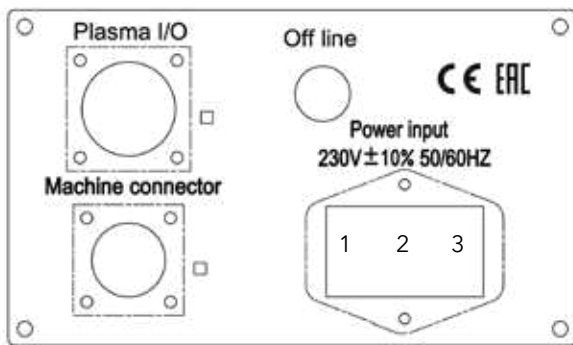

CE panel for EX-TRACK®CNC

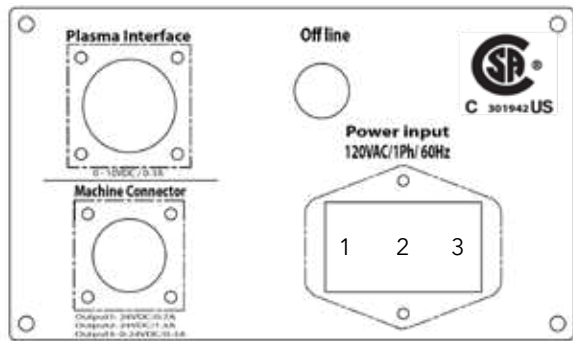

CSA panel for EX-TRACK®CNC

### 10.6.2. Converting table for "Position Up Time" parameter

Position Up Time (s)	Initial piercing height (mm)
003	0
004	2
005	3,5
006	5
007	6,8
008	8

\* The values can be different on the different EX-TRACK®CNC. In case to find exact pierce height turn off the plasma power source and start cutting sequence without plasma. When the torch finds initial zero height of the material, then will rise into the yours adjusted "Position Up time" height and stop the cutting sequence automatically. Then is possible to measure piercing height of the torch.

## SECTION 11.

### **Warranty terms and conditions:**

The EX-TRACK® CNC Cutting System comes with a 12-month warranty cover against manufacturing defects, it is valid only if the system has been used and maintained in accordance with the instruction manual. The warranty is valid from date of invoice, and is not transferable. See the exact terms and conditions of the warranty on the Bill of Sale or Invoice.



### **The warranty will not be valid if:**

1. After purchasing, damage is caused by improper transportation or storage.
2. Incorrect electrical input supply.
3. No proof of purchase.
4. The warranty card does not match the device.
5. Damage is caused by acts of nature, or force majeure.
6. Damage caused by incorrect/unauthorized use.
7. Unauthorized repair/modifications to the EX-TRACK® CNC Cutting System.
8. Damage/failure caused by use of non Thermacut parts/components

## SECTION 12.

### Certification and compliance symbols:

#### **S Mark;**

The  mark indicates that the power supply and torch are suitable for use in environments with danger of electrocution. The hand torches must have shielded consumable parts fitted to maintain  mark compliance.

#### **CE Mark;**

This marking signifies the manufacturer's declaration of conformity to applicable European directives and standards (EMC & LVD).

#### **C-Tick Mark;**

This mark signifies compliance with appropriate Australian EMC standard.

#### **CSA Mark;**

The products listed below are eligible to bear the CSA Mark shown with adjacent indicators 'C' and 'US' for Canada and US or with adjacent indicator 'US' for US only or without either indicator for Canada only.

## SECTION 13.

### Disposal of product at the end of lifetime

#### Use and disposal of waste

Wrapping paper and corrugated paperboard – place in paper recycling containers. Packing foil, PE bags, plastic elements – place in plastic recycling containers.

#### Disposal of products at the end of lifetime

Disposal of electric and electronic equipment (valid in EU member countries and other European countries with an implemented recycling system).

It is not allowed to treat this product as domestic waste. Hand over the product to the specified location for recycling electric and electronic equipment. Prevent negative impacts on human health and the environment by correctly recycling your product.

Recycling contributes to preserving natural resources. For more information on the recycling of this product, refer to your manufacturer, who will be able to handle the disposal for you or refer to your local authority, domestic waste processing organization or store, where you purchased the product.

For local disposal, the local regulations for the disposal of electrical and electronic scrap as well as materials must be observed.

This product complies with EU directive requirements on electromagnetic compatibility and electrical safety.



#### RoHS statement

Hereby Thermacut, k.s. confirms that to its knowledge all EX-TRACK® portable cutting systems (unless otherwise expressly signed) sold by Thermacut, k.s. fulfill the requirements of the EU directive 2011/65/EU. These products are compatible with the current RoHS requirements for the 7 substances (max 0.1% by weight in homogeneous materials for lead, mercury, hexavalent chromium, polybrominated biphenyls (PBB), polybrominated diphenyl ethers (PBDE), Deca-BDE and max 0.01% for cadmium).

---

**Enclosure: Graphics library**

Shape 1 .....	104
Shape 2 .....	104
Shape 3 .....	104
Shape 4 .....	105
Shape 5 .....	105
Shape 6 .....	105
Shape 7 .....	106
Shape 8 .....	106
Shape 9 .....	106
Shape 10 .....	107
Shape 11 .....	107
Shape 12 .....	107
Shape 13 .....	108
Shape 14 .....	108
Shape 15 .....	108
Shape 16 .....	109
Shape 17 .....	109
Shape 18 .....	109
Shape 19 .....	110
Shape 20 .....	110
Shape 21 .....	110
Shape 22 .....	111
Shape 23 .....	111
Shape 24 .....	111
Shape 25 .....	112
Shape 26 .....	112
Shape 27 .....	112
Shape 28 .....	113
Shape 29 .....	113
Shape 30 .....	113
Shape 31 .....	114
Shape 32 .....	114
Shape 33 .....	114
Shape 34 .....	115
Shape 35 .....	115
Shape 36 .....	115
Shape 37 .....	116
Shape 38 .....	116
Shape 39 .....	116
Shape 40 .....	117
Shape 41 .....	117

Shape 42 ..... 117  
 Shape 43 ..... 118  
 Shape 44 ..... 118  
 Shape 45 ..... 118  
 Shape 46 ..... 119  
 Shape 47 ..... 119  
 Shape 48 ..... 119  
 Shape 49 ..... 120  
 Shape 50 ..... 120

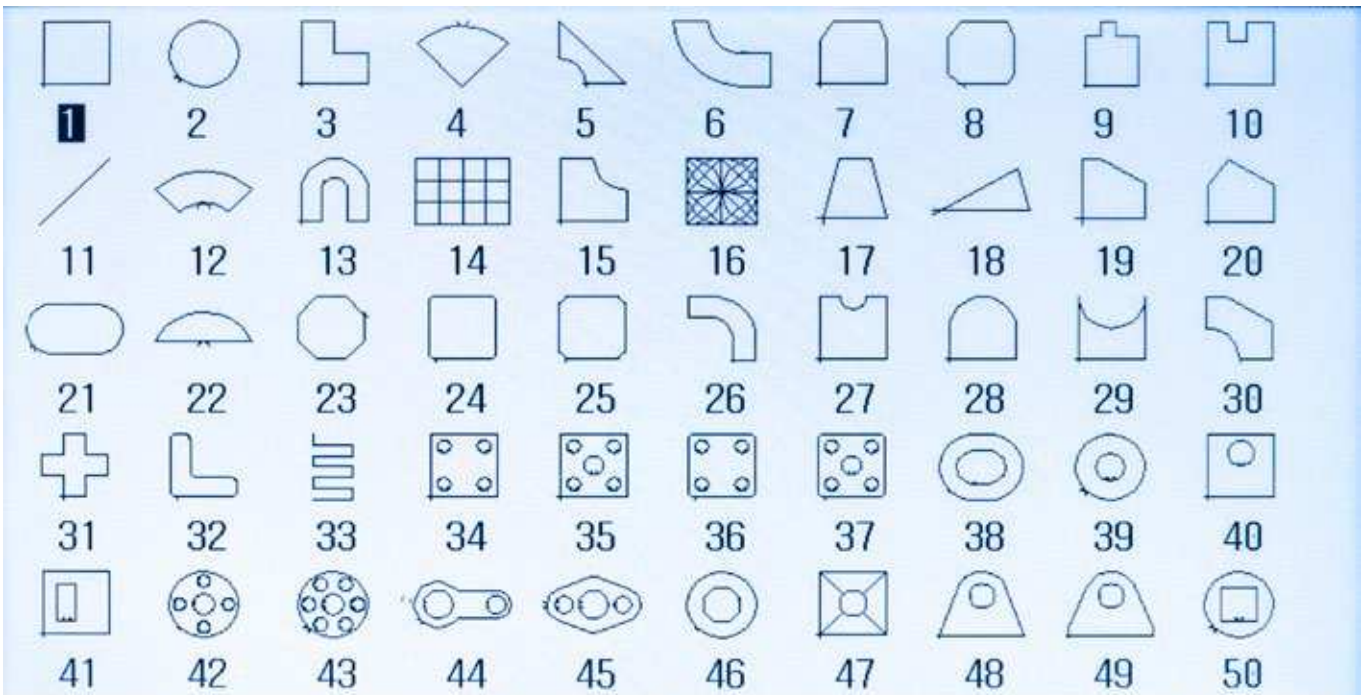

### Shape 1



### Shape 2

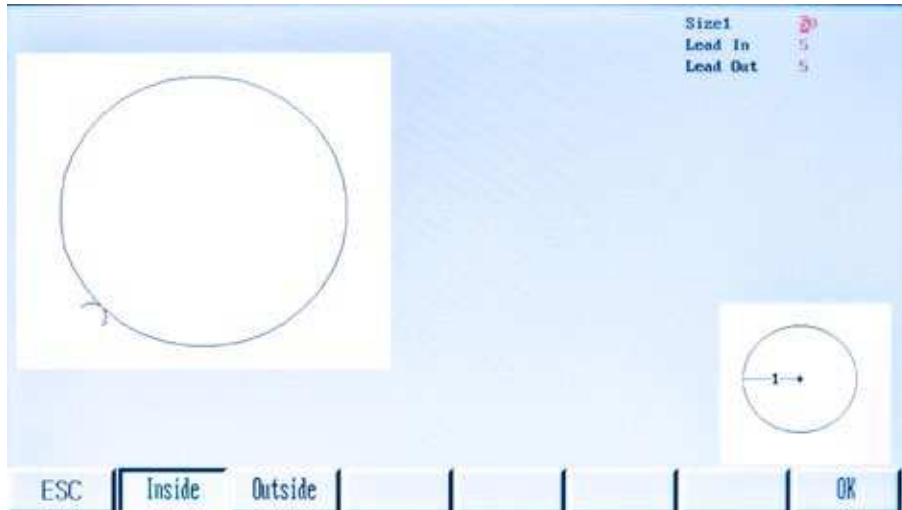

### Shape 3

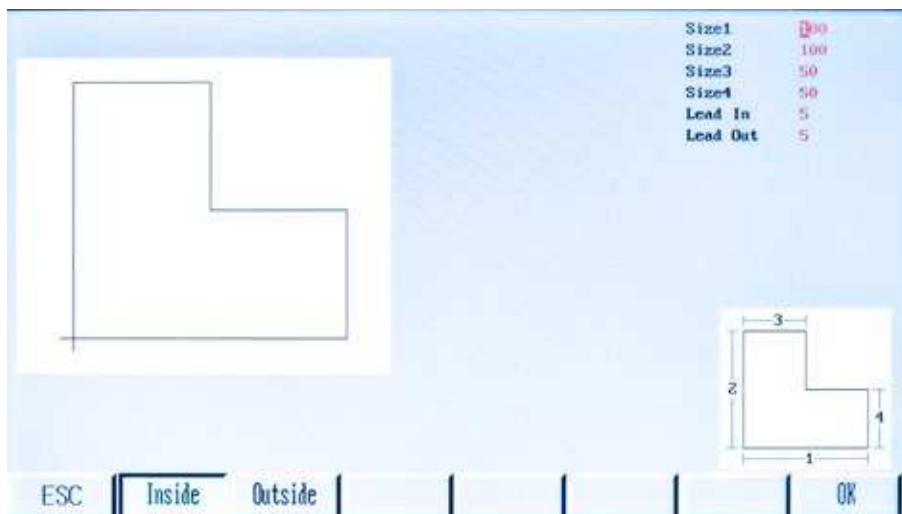



### Shape 4

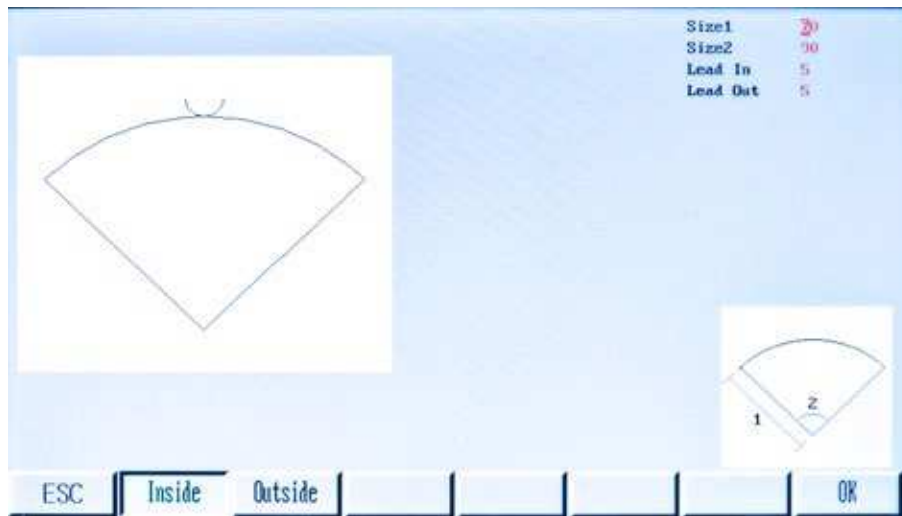

### Shape 5

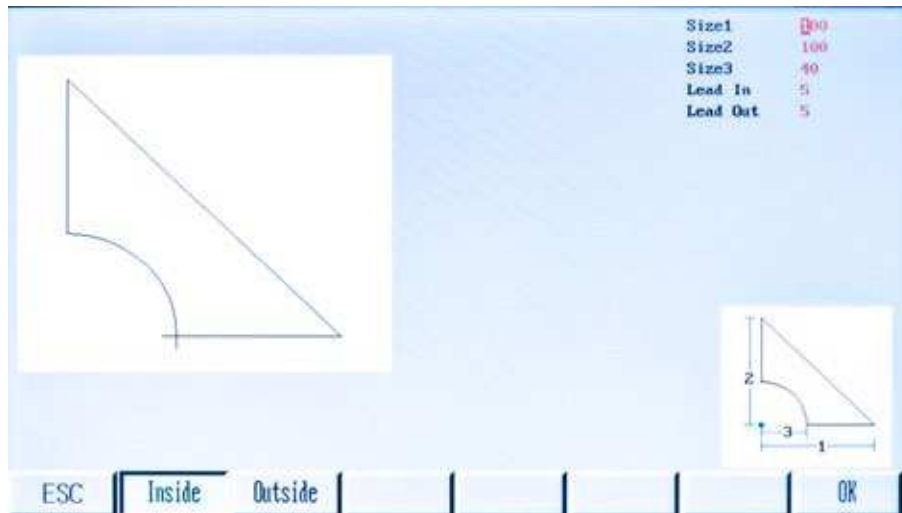

### Shape 6

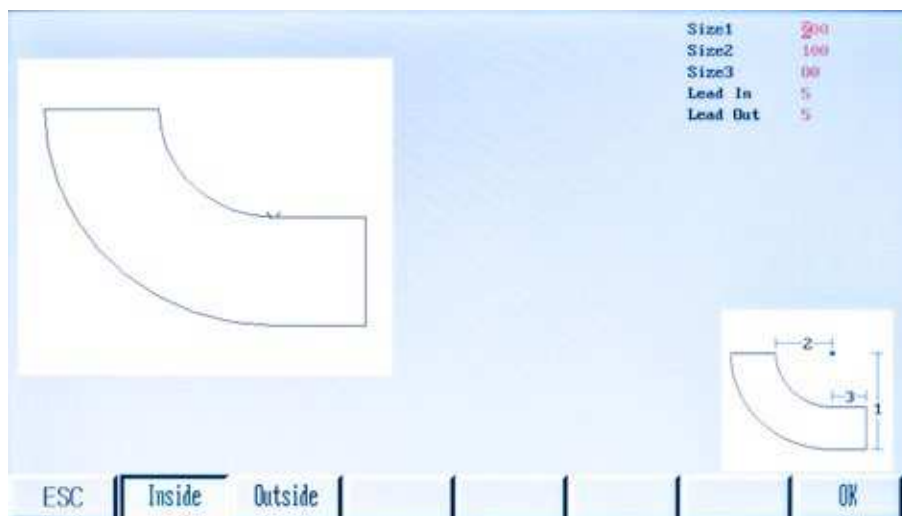

## Shape 7

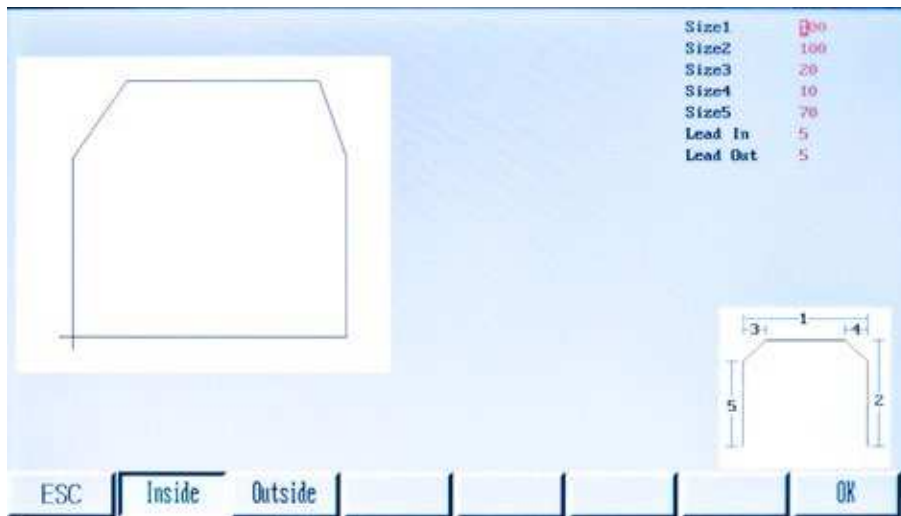

## Shape 8



## Shape 9

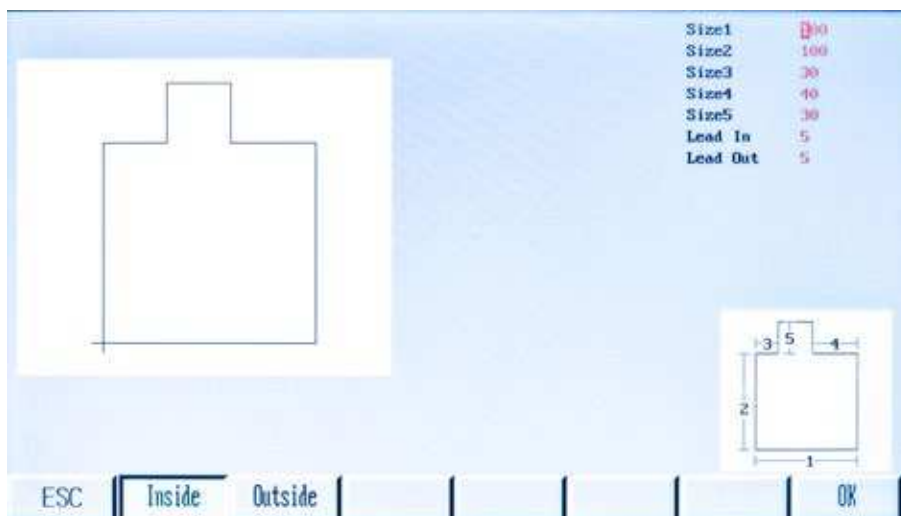

### Shape 10

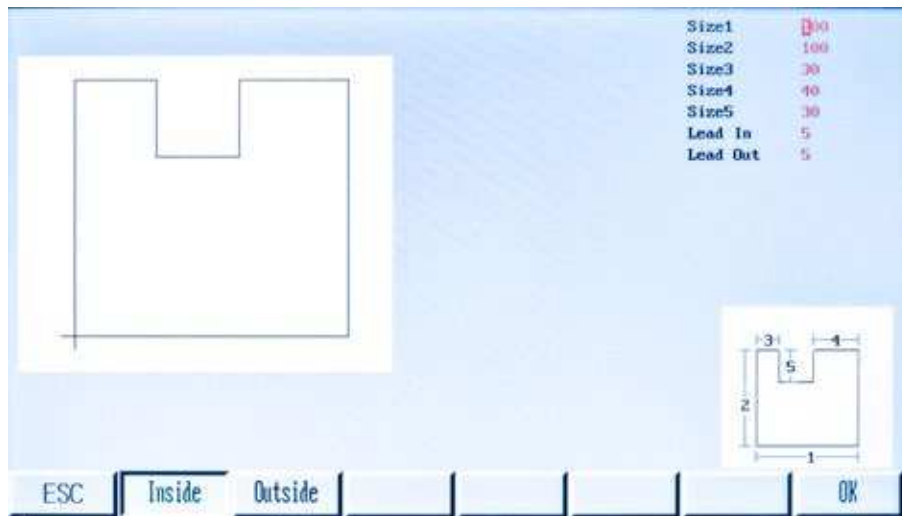

### Shape 11



### Shape 12

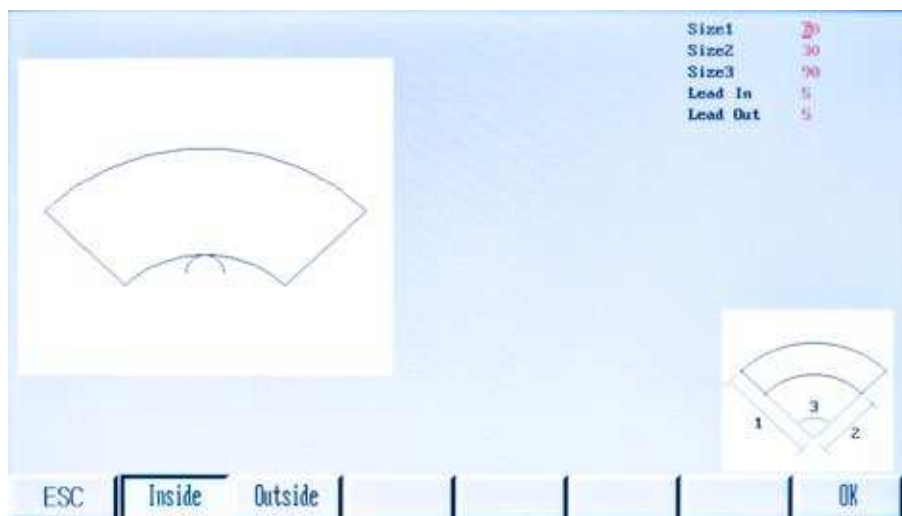

### Shape 13

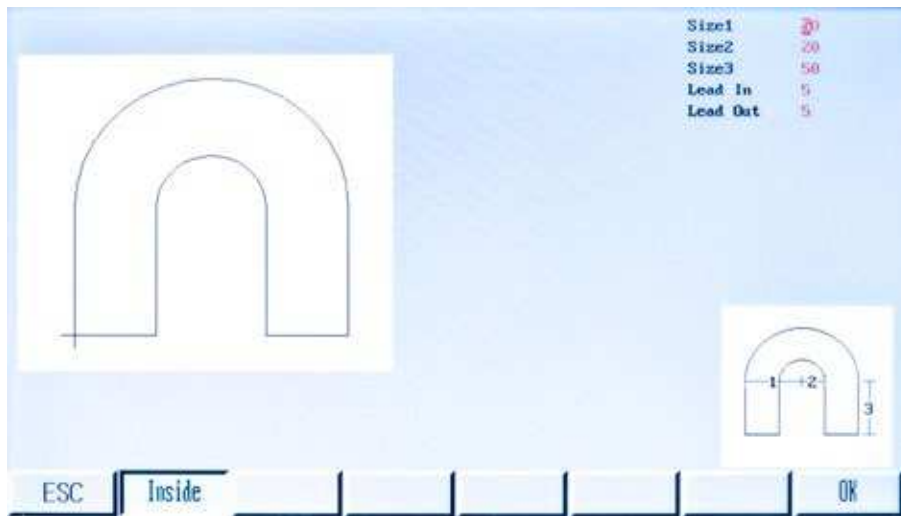

### Shape 14

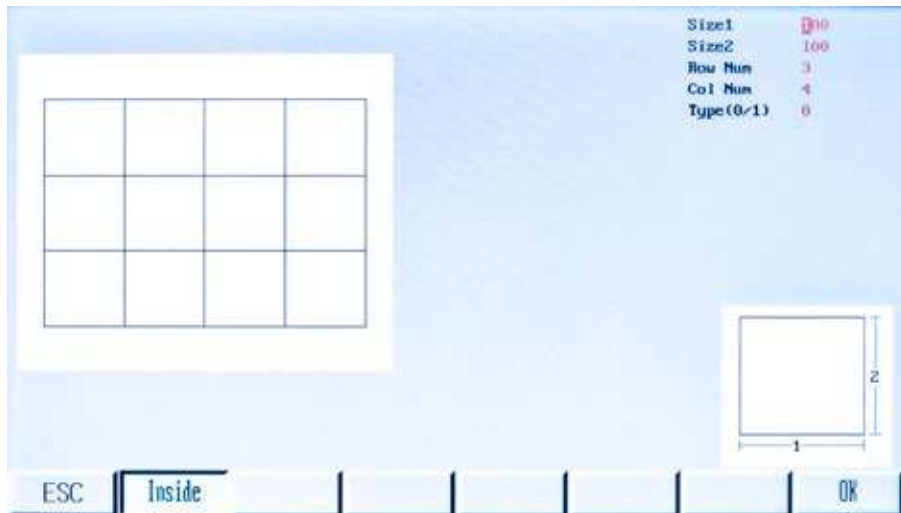

### Shape 15

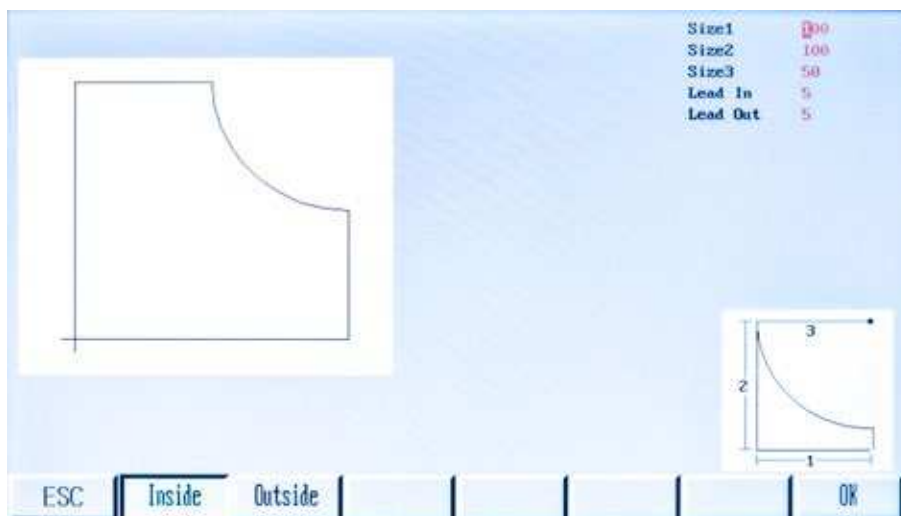

### Shape 16

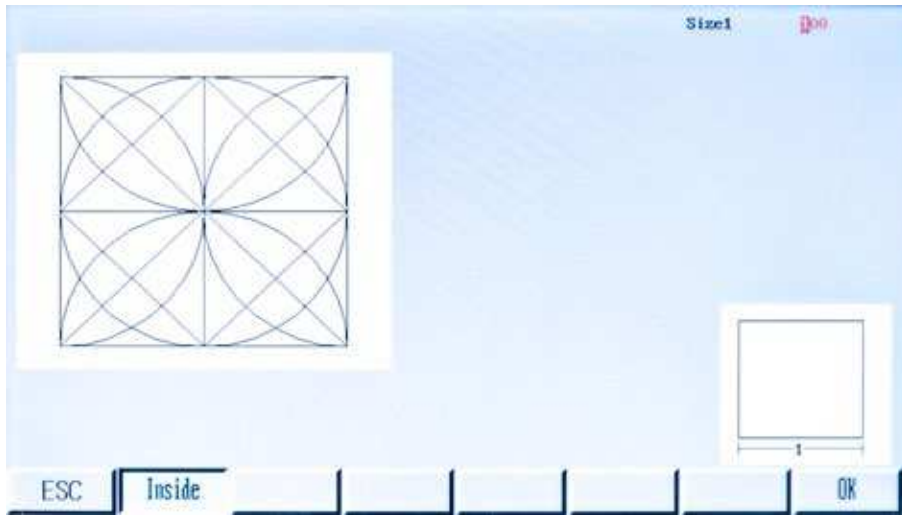

### Shape 17

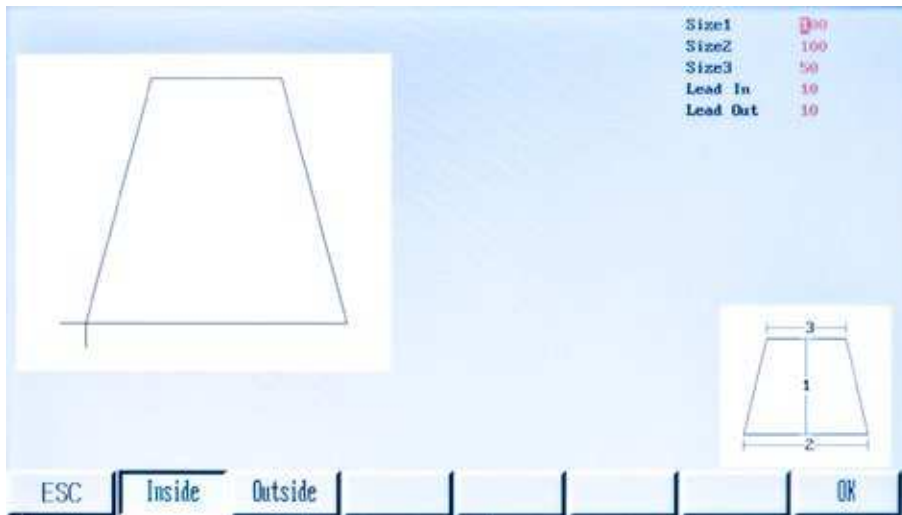

### Shape 18

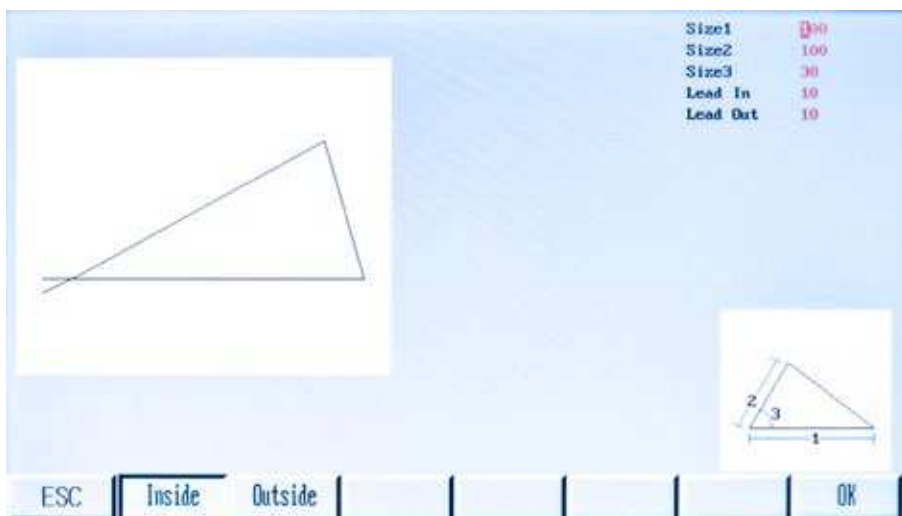

### Shape 19

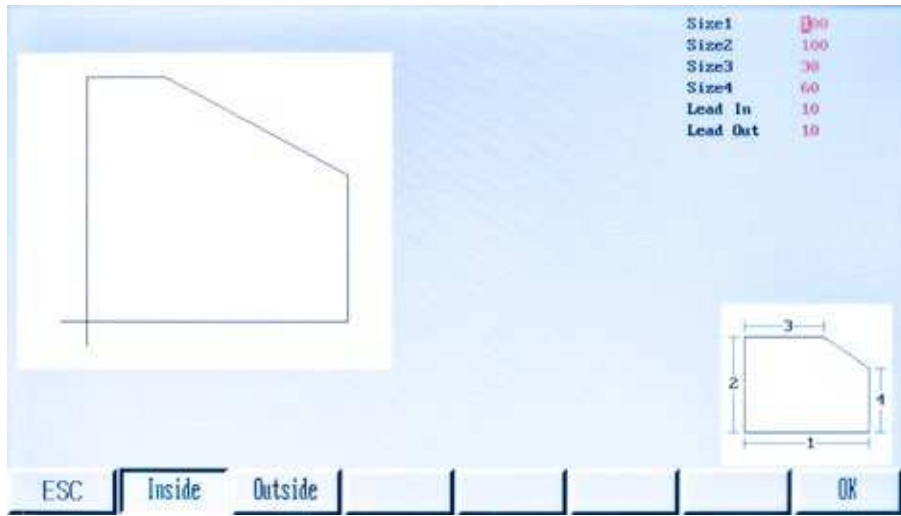

### Shape 20

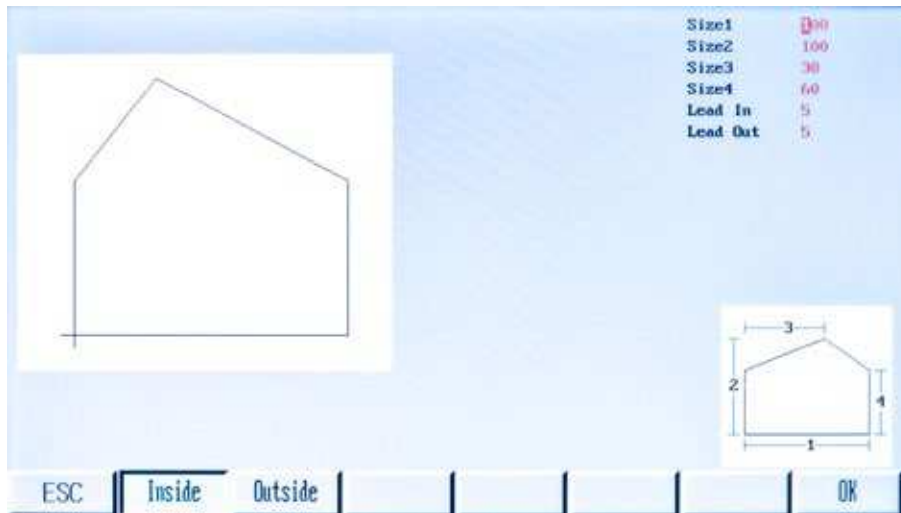

### Shape 21

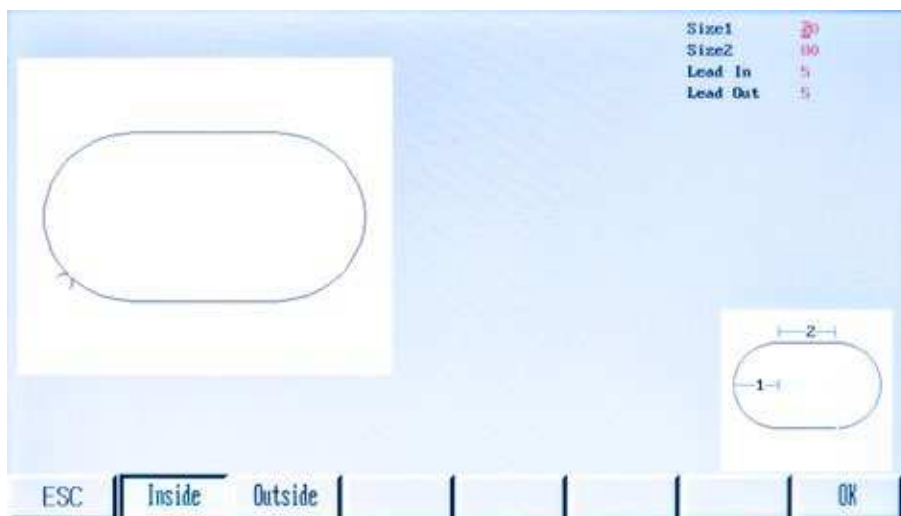

### Shape 22

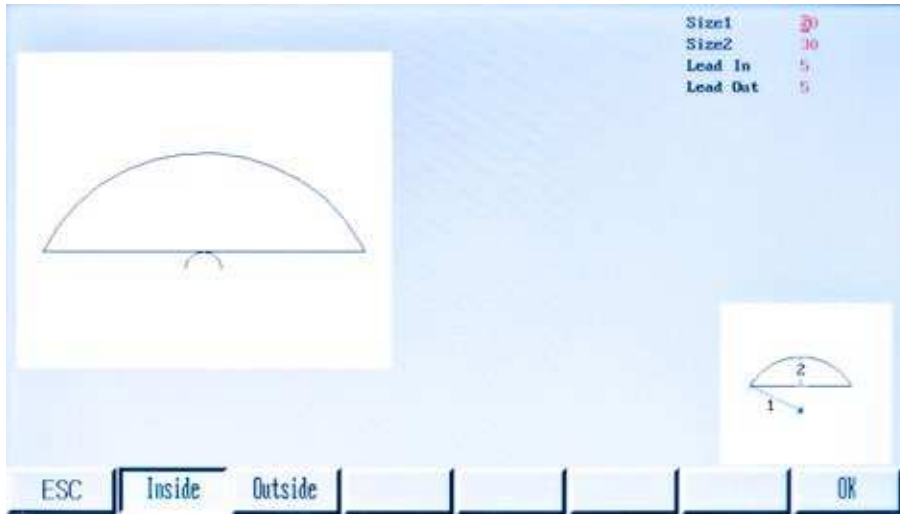

### Shape 23

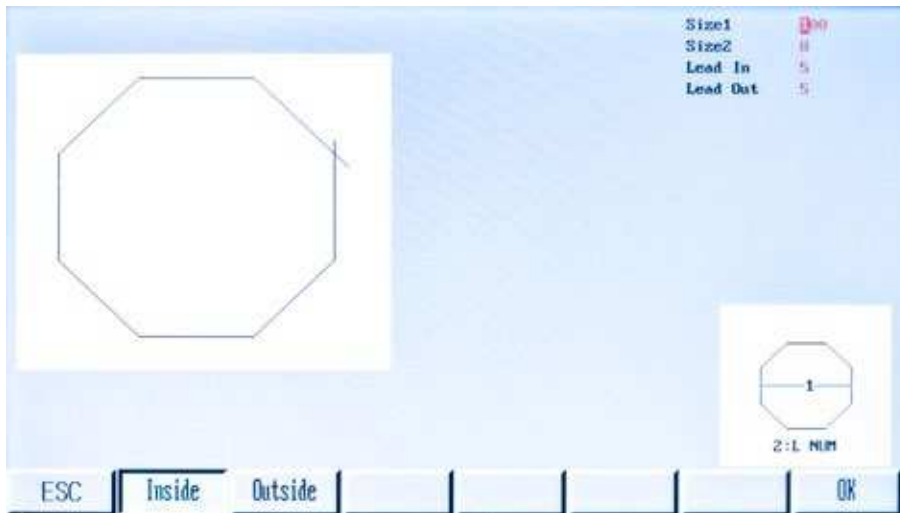

### Shape 24



### Shape 25

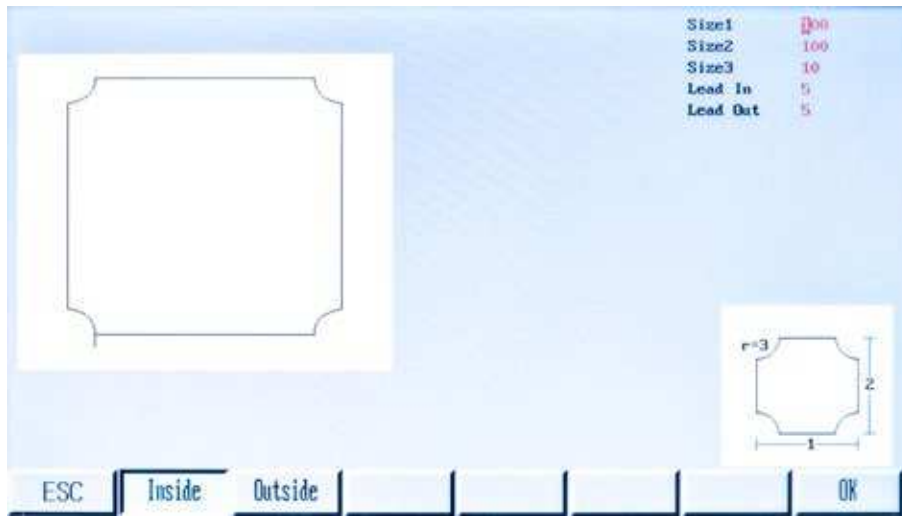

### Shape 26



### Shape 27

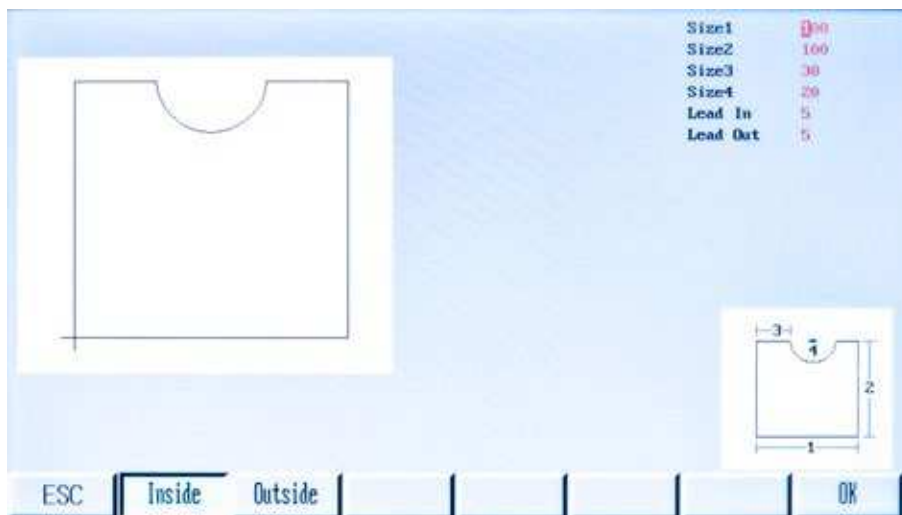



### Shape 28

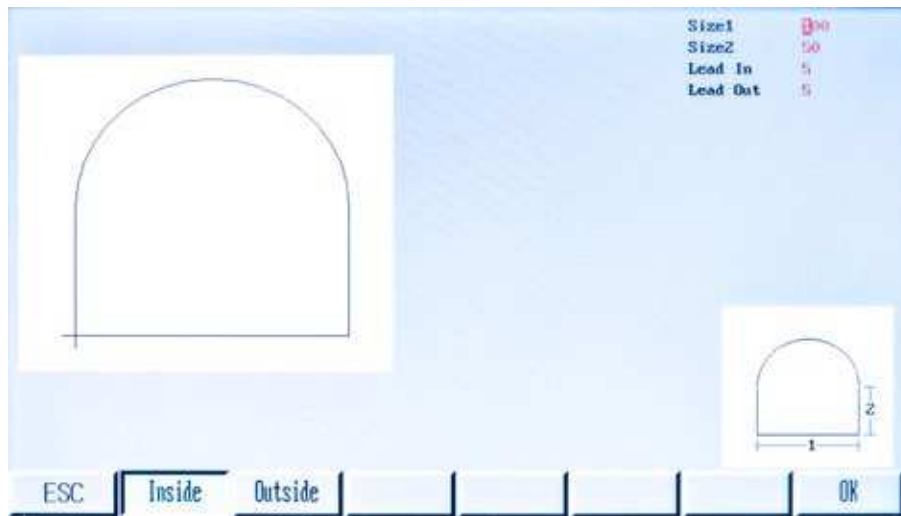

### Shape 29

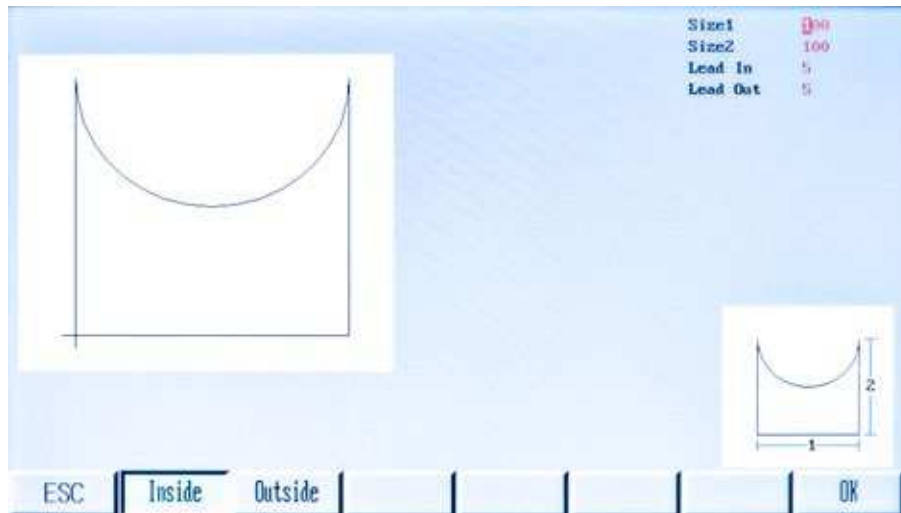

### Shape 30

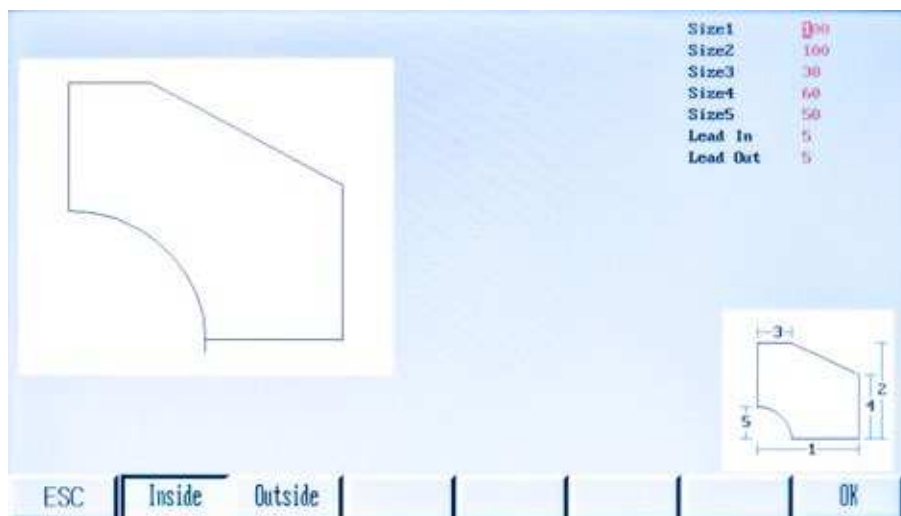

### Shape 31

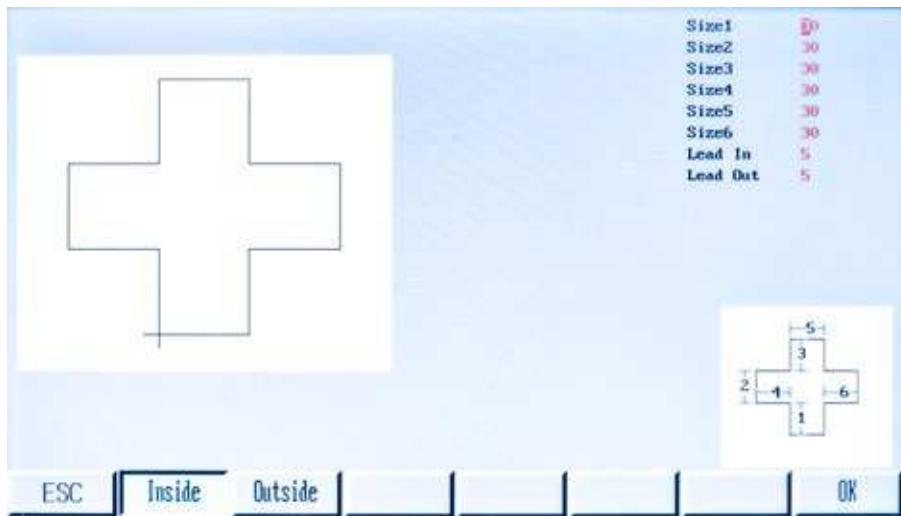

### Shape 32



### Shape 33



### Shape 34

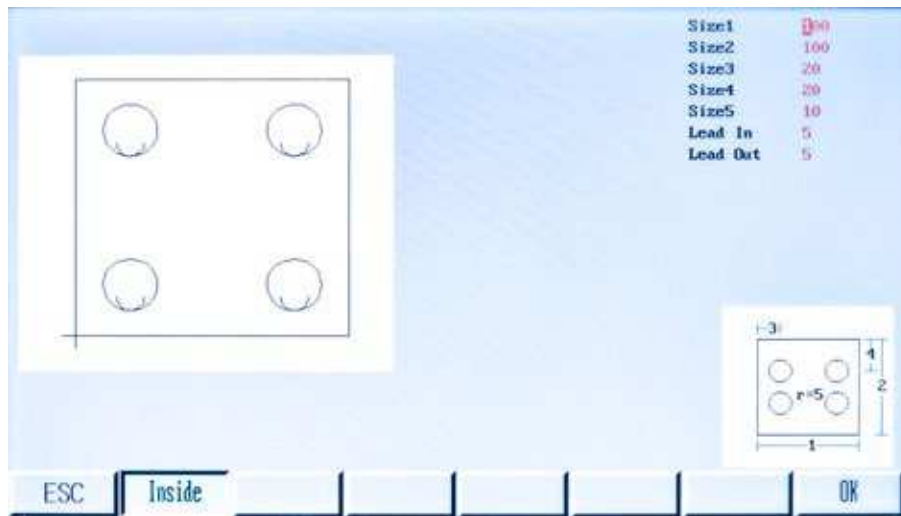

### Shape 35

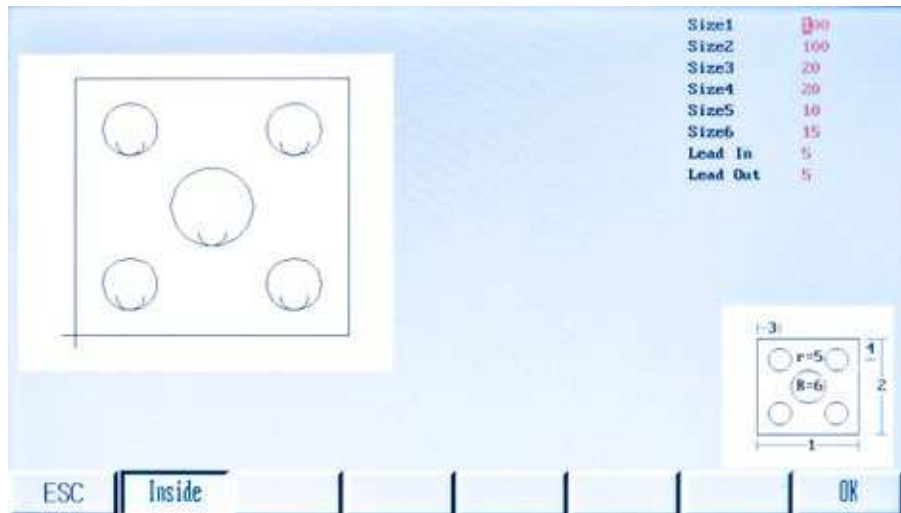

### Shape 36



### Shape 37

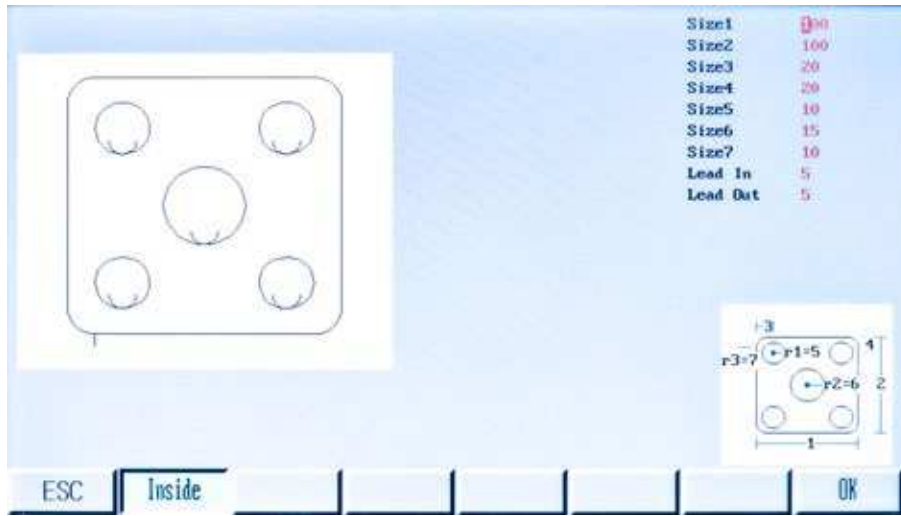

### Shape 38

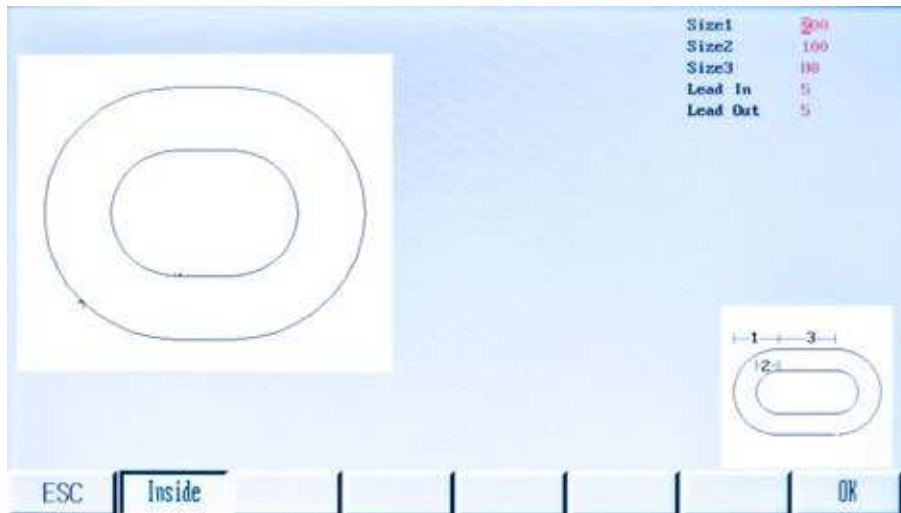

### Shape 39

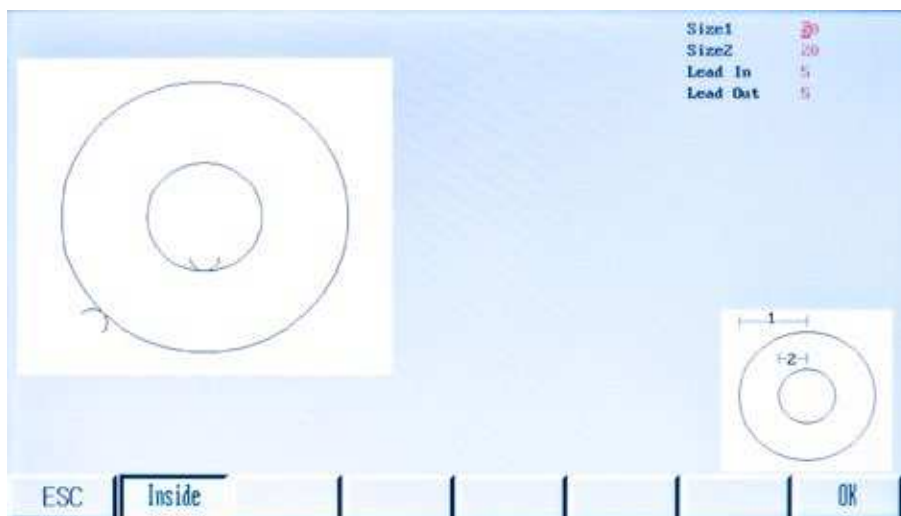

## Shape 40

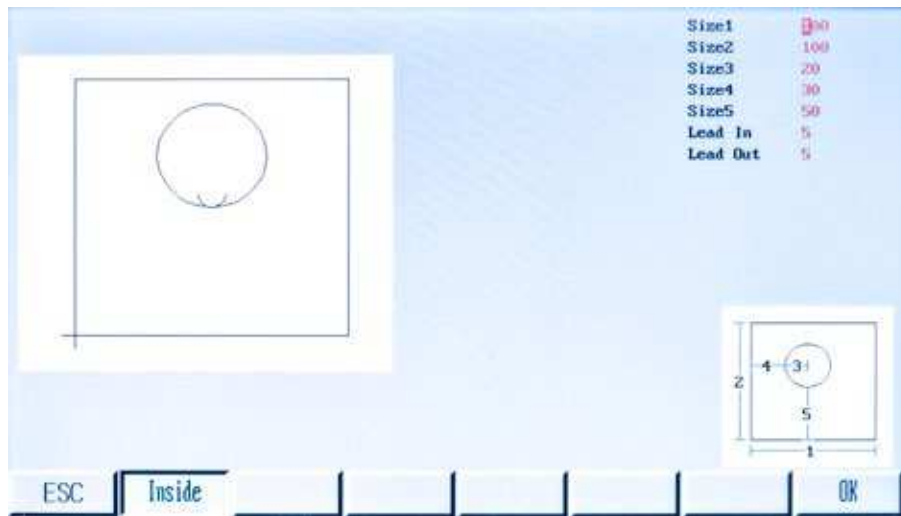

## Shape 41



## Shape 42

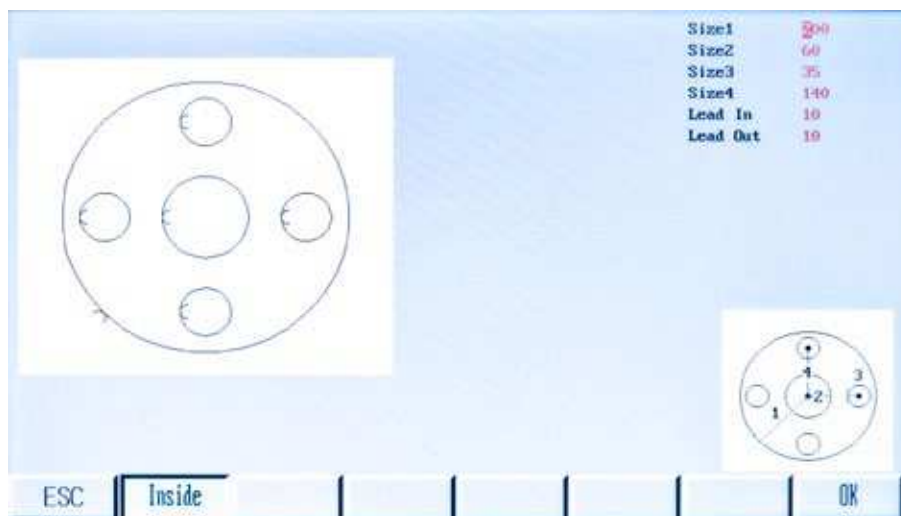

### Shape 43

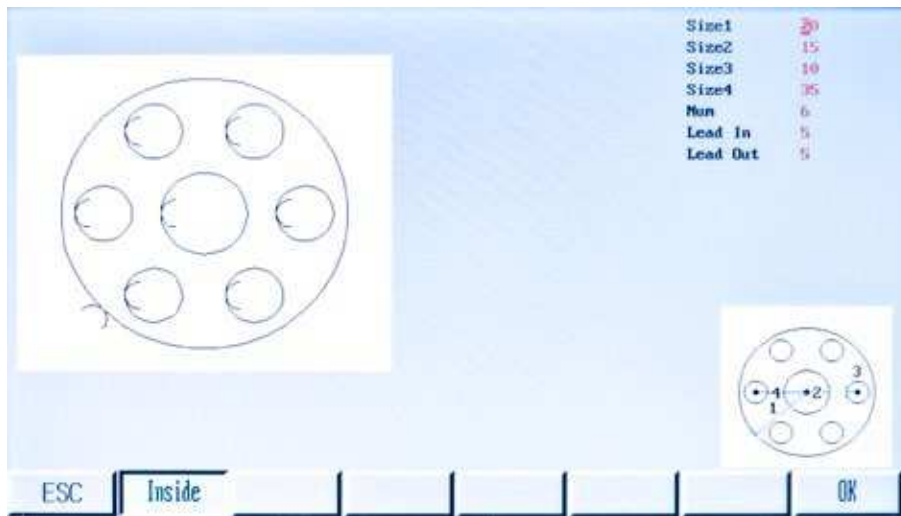

### Shape 44

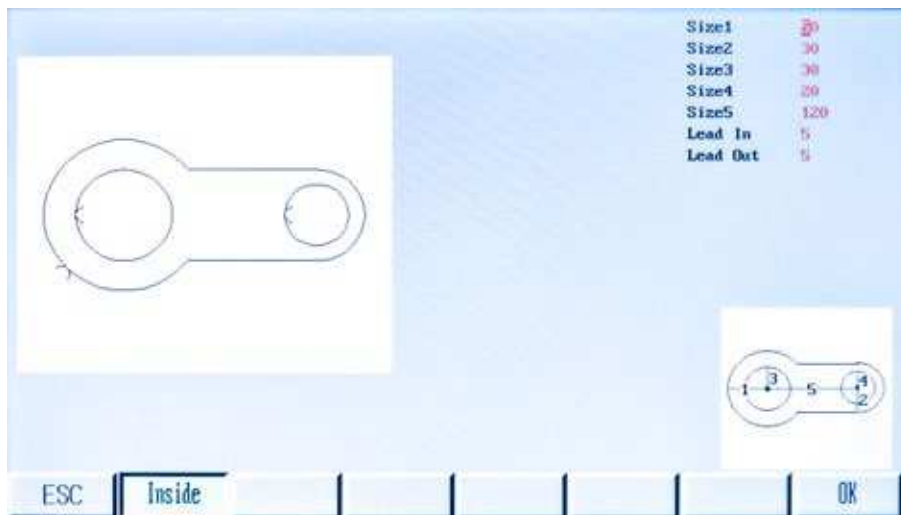

### Shape 45

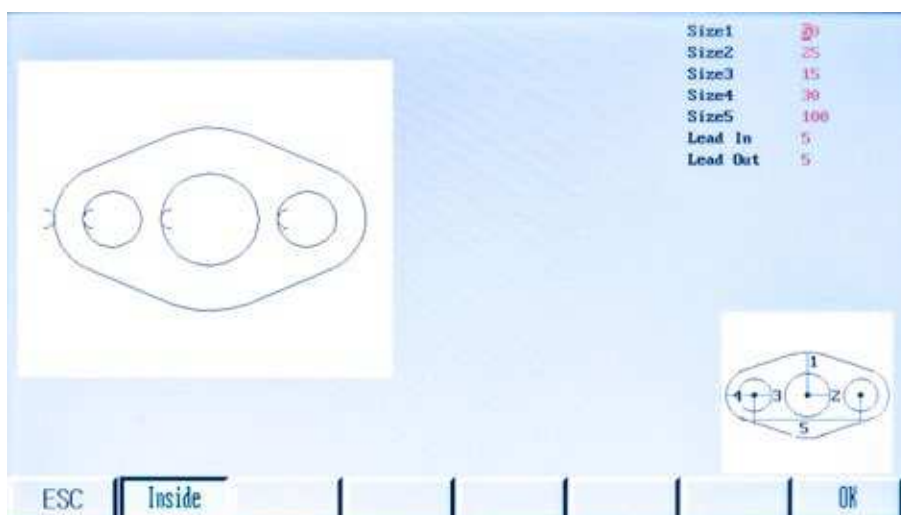

### Shape 46

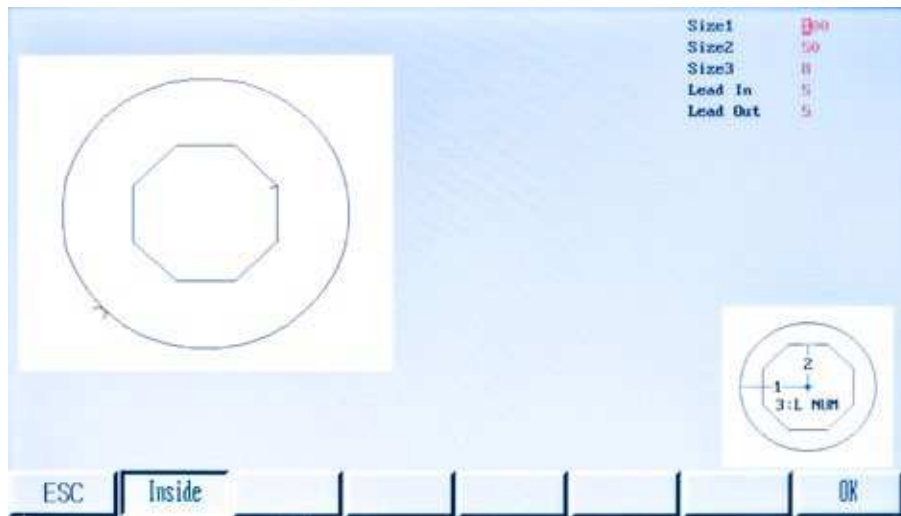

### Shape 47

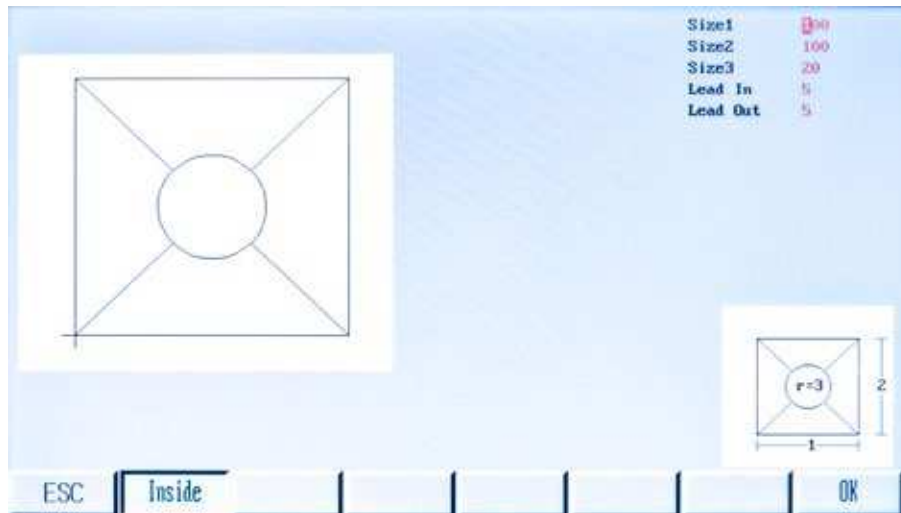

### Shape 48

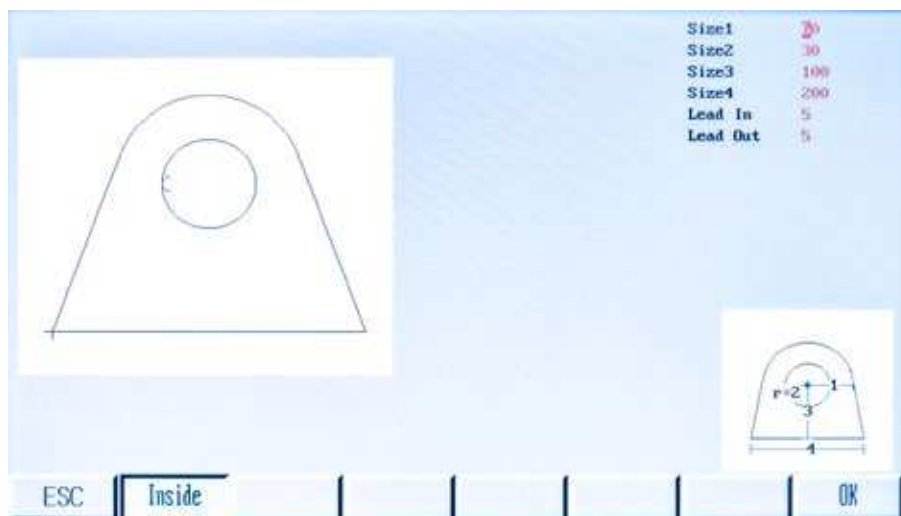

### Shape 49

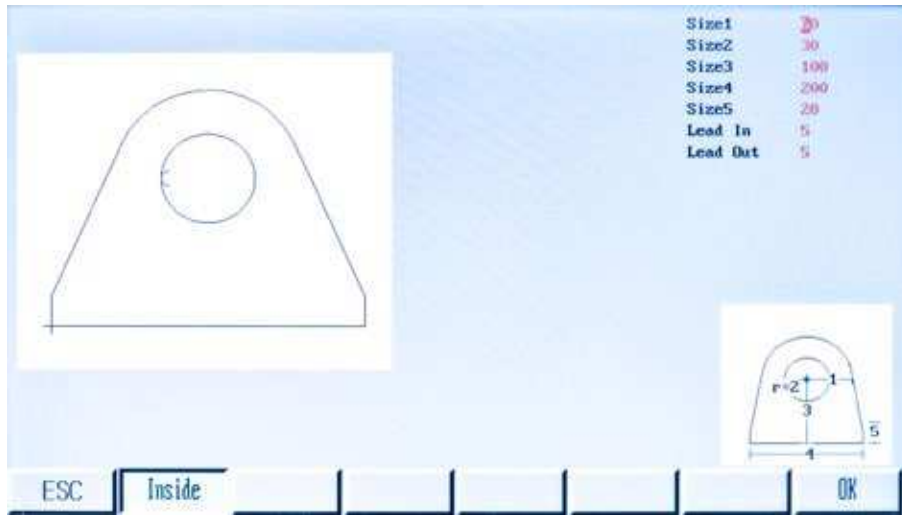

### Shape 50

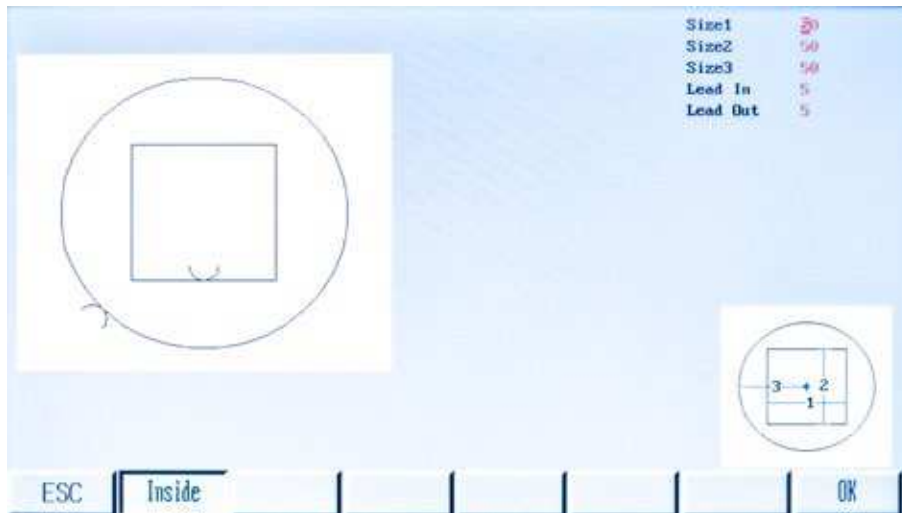



## Enclosure 2: EX-TRACK® CNC Accessories

### EX-TRACK® CNC Accessories:

#### EX-TRACK® oxy fuel upgrade kit



##### Content:

- EX-TRAFLEME® PRO torch for EX-TRACK® CNC
- 5 pcs cutting nozzle 25-40 mm
- 1 pc heating nozzle 3-100 mm,
- Operator manual

- More precise gas pressure settings thanks to integrated manometers
- Integrated flashback arrestors for each gas
- High performance cutting
- Special o-rings to avoid the mixing of gases
- Quick-change system with stainless steel nut
- Changeable injector
- Separate parts (torch + valves + manometers)
- Possibility to cut with propane and acetylene
- Consumables line : MESSER® GRICUT® 9230-PMYF

**Ref. Nr.: EX-0-717-001**

#### Display protection cover polycarbonate 3 mm



Display protection cover is made from 3mm polycarbonate and it is protection of display and keyboard of the EX-TRACK® CNC unit.

**Ref. Nr.: EX-0-717-002**

## Enclosure 3: Spare parts

### SPARE PARTS:

---

Exploded view A.....	24
Exploded view B.....	26
Exploded view C.....	28

# Exploded view A

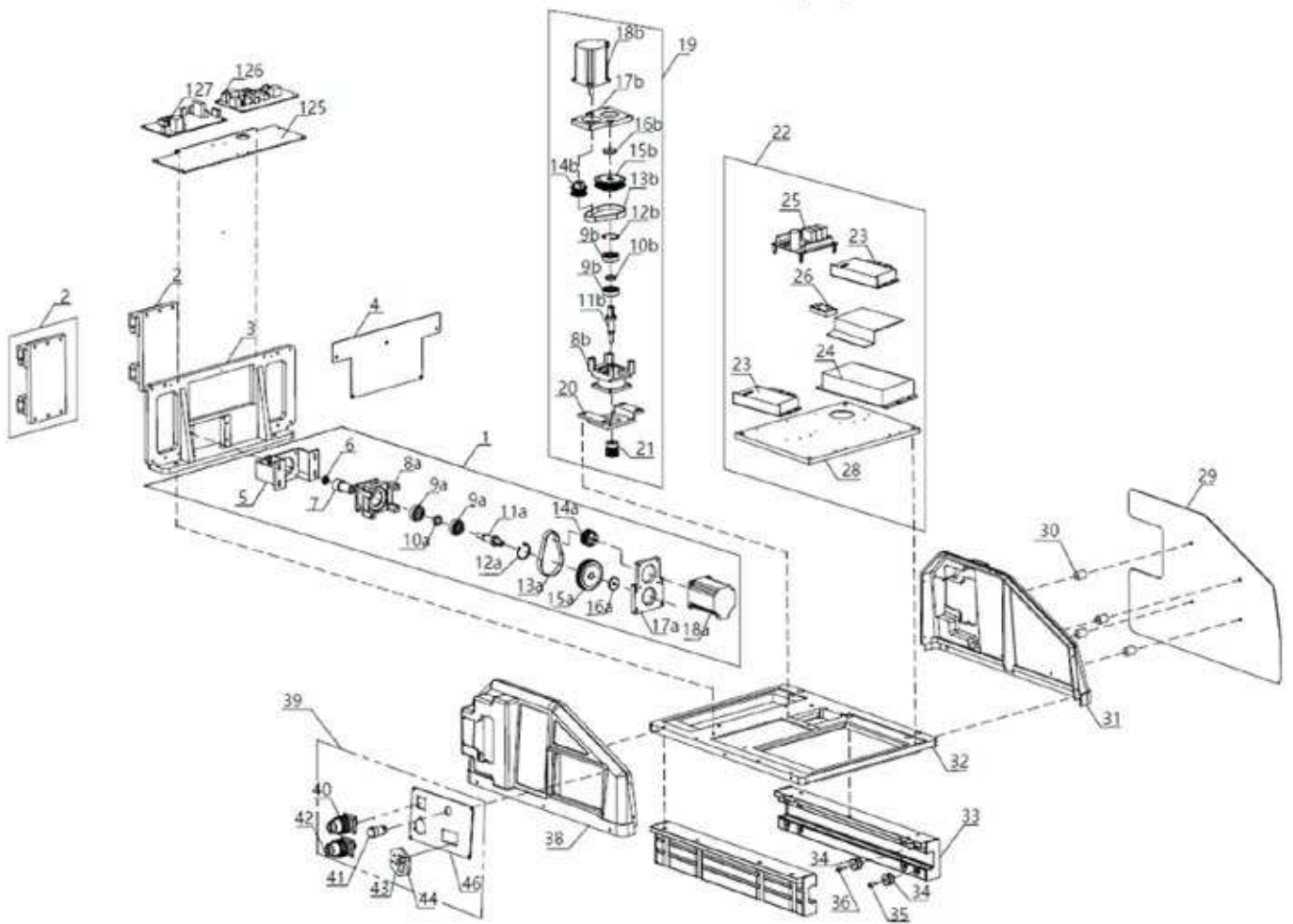

## Parts description A

Item	Part No.	DESCRIPTION
1	EX-0-706-001	X-motion (Transverse) motor assembly
2	EX-0-706-002	Sliding block (AL 450*51*82)
3	EX-0-706-003	Mount.panel (AL 396*57*185.5)
4	EX-0-706-004	Cover board
5	EX-0-706-005	Horizontal motor mount. plate
6	EX-0-706-006	Bearing (628/Ø16)
7	EX-0-706-007	Horizontal output Pinion gear (Ø23*28)
8a, 8b	EX-0-706-008	Gear box (AL 57*77*62)
9a, 9b	EX-0-706-009	Bearing (6201/Ø32)
10a, 10b	EX-0-706-010	Bearing cover (Ø20*5mm)
11a, 11b	EX-0-706-011	Transmission shaft (Ø20*76mm)
12a, 12b	EX-0-706-012	Inner retaining ring (Ø34.4)
13a, 13b	EX-0-706-013	Belt (90XL)
14a, 14b	EX-0-706-014	Small belt wheel (AL Ø32*25)
15a, 15b	EX-0-706-015	Large belt wheel (AL Ø61*20)
16a, 16b	EX-0-706-016	Bearing cover (Ø25*5mm)
17a, 17b	EX-0-706-017	Motor mount.plate(106*77*9.5)
18a, 18b	EX-0-706-018	Stepper motor (24V/3A/57 steps)
19	EX-0-706-019	Y-motion motor assembly
20	EX-0-706-020	Lifter motor mnt.plate (Ø23*54)
21	EX-0-706-021	Pinion Gear
22	EX-0-706-022	Stepper motor P.S. block assy
23	EX-0-706-023	Stepper motor driver (DM556D)
24	EX-0-706-024	Power supply 110/230V
25	EX-0-706-025	Relay PCB
26	EX-0-706-026	Connector (TB1503 600V/15A)
28	EX-0-706-028	Stepper motor P.S. mount.plate
29	EX-0-706-029	Heat Shield
30	EX-0-706-030	Spacer element

Item	Part No.	DESCRIPTION
31	EX-0-706-031	Right-side plate
32	EX-0-706-032	Base plate
33	EX-0-706-033	Right slide block (46*28*458)
34	EX-0-706-034	V-type wheel
35	EX-0-706-035	Eccentric screw (M6)
36	EX-0-706-036	Fixing screw (M8)
37	EX-0-706-037	Left slide block (46*28*458)
38	EX-0-706-038	Left-side plate
39	EX-0-706-039	Connector panel assembly
40	EX-0-706-040	CNC Interface 14-pin socket
41	EX-0-706-041	Off-Line switch (Ø18mm)
42	EX-0-706-042	Machine Control 10-pin socket (Ø44)
43	EX-0-706-043	Flat Plug Power Socket
46	EX-0-706-044	Connector panel
44	EX-0-706-114	Glass Fuse (250VAC/3A)
45	EX-0-706-115	Emergency Stop button
47	EX-0-706-045	Rear cover
48	EX-0-706-046	Controller mounting plate
49	EX-0-706-047	Controller (SF-2100C)
125	EX-0-706-110	THC mounting plate
126	EX-0-706-111	Pressing board THC
127	EX-0-706-112	Control board THC

# Exploded view B

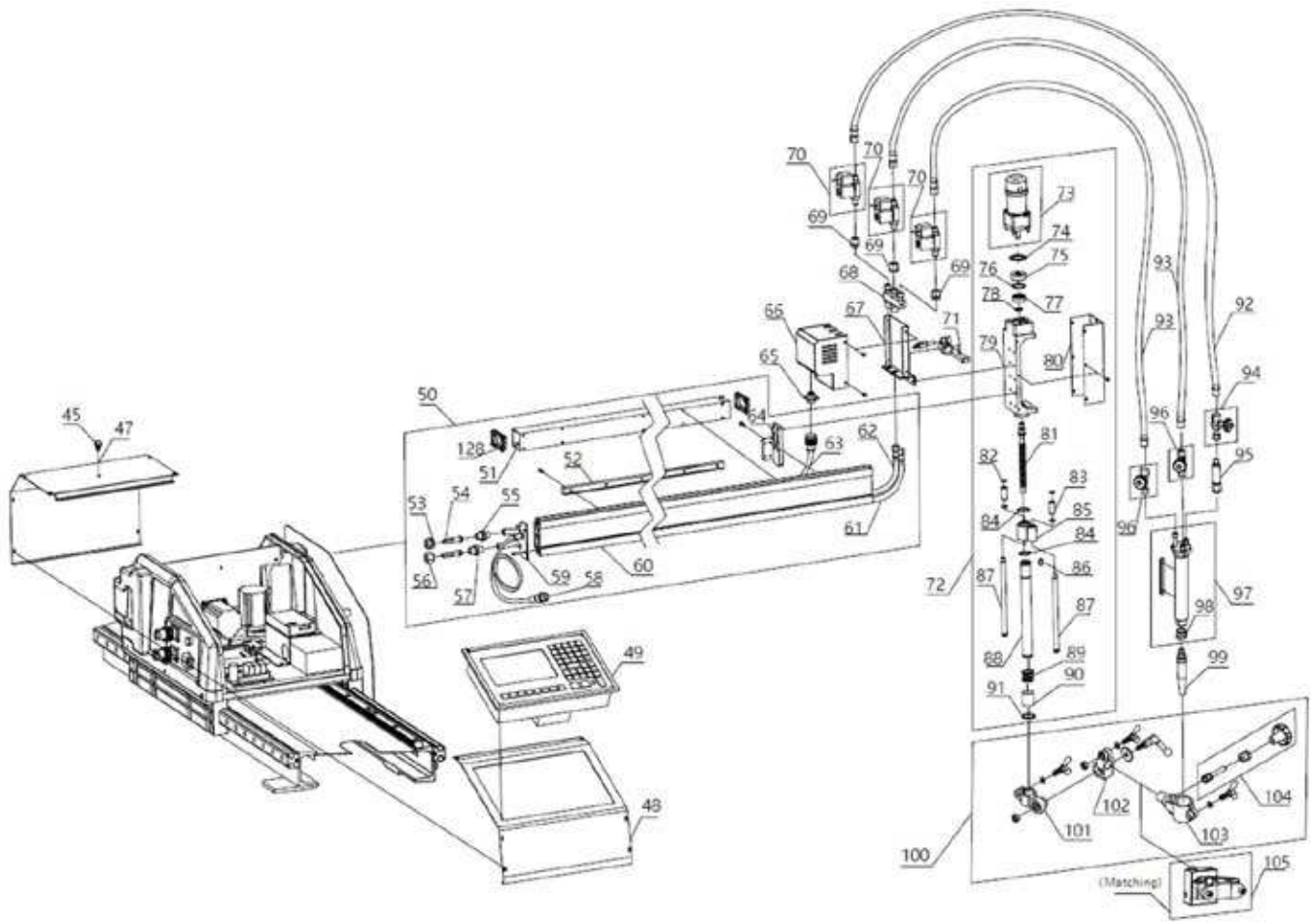

## Parts description B

Item	Part No.	DESCRIPTION
50	EX-0-706-048	Crossbar assembly
51	EX-0-706-049	STL. steel sqr. tube (50*50*1)
52	EX-0-706-050	Gear Rack (1.273M)
53	EX-0-708-001	Fuel gas nut (UNF 9/16"-18 LH)
54	EX-0-708-002	Hose nipple
55	EX-0-708-003	Fuel gas coupl.(UNF9/16"-18LH)
56	EX-0-708-004	Oxygen nut (UNF 9/16"-18)
57	EX-0-708-005	Oxygen coupling (UNF 9/16"-18)
58	EX-0-706-056	Mach. ctrl 10-pin plug w/cable
59	EX-0-706-057	Coupling mounting plate
60	EX-0-706-058	Crossbar (aluminum)
61	EX-0-708-006	Crossbar Oxy hose (Øin 1/4")
62	EX-0-708-007	Crossbar Fuel gas hose (Øin 1/4")
63	EX-0-706-061	Gas console 7-pin plug (Ø31)
64	EX-0-706-062	Lifter holder
65	EX-0-706-064	Gas console 7-pin socket Ø21
66	EX-0-706-065	Gas console cover
67	EX-0-706-066	Gas console mounting plate
68	EX-0-708-008	Gas distributor (88*16*70)
69	EX-0-708-009	Right-left union nut
70	EX-0-706-051	Solenoid valve (24VDC/3W)
71	EX-0-706-070	Torch holder console
72	EX-0-706-071	Torch lifter assembly (THC)
73	EX-0-706-072	Lifter motor assembly
74	EX-0-706-073	Flange bushing
75	EX-0-706-074	Clamp ring (AL Ø31*11mm)
76	EX-0-706-075	Inner retaining ring (Ø28mm)
77	EX-0-706-076	Bearing (Ø28*12*8mm (6001)
78	EX-0-706-077	Outer retaining ring (missing size)
79	EX-0-706-078	Lifter
80	EX-0-706-079	Lifter front cover 65*46.5*174

Item	Part No.	DESCRIPTION
81	EX-0-706-080	Lifter screw rod (M12*3)
82	EX-0-706-081	Steel baffle ring (Ø13mm)
83	EX-0-706-082	Bearing (Ø20)
84	EX-0-706-083	Retaining ring (Ø20)
85	EX-0-706-084	Guide holder
86	EX-0-706-085	Shaft square key (6*6*30)
87	EX-0-706-086	Guide axle (Ø10*174mm)
88	EX-0-706-087	Lifter housing
89	EX-0-706-088	Spring (Ø24.5*2)
90	EX-0-706-089	Bearing (Øout 23/Øin 20mm)
91	EX-0-706-090	Steel baffle ring (Ø25)
92	EX-0-708-010	Fuel gas hose (Øin 1/4")
93	EX-0-708-011	Oxygen "BLUE" hose (Øin 1/4")
94	EX-0-708-012	Fuel gas valve (UNF9/16"-18LH)
95	EX-0-708-013	Flashback arrestor UNF9/16"-18LH
96	EX-0-708-014	Oxygen valve (UNF 9/16"-18)
97	EX-0-708-015	Oxy-fuel torch assembly
98	EX-0-708-016	Cutting nozzle nut (CU Ø22*19)
99	EX-0-708-017	Cutting nozzle 00 (5-10mm)
100	EX-0-706-099	Oxy-fuel torch holder assembly
101	EX-0-706-100	Vertical clamp holder
102	EX-0-706-101	Horizontal clamp holder
103	EX-0-706-102	Oxy-fuel torch holder
104	EX-0-706-103	Pinion assembly
105	EX-0-706-104	Plasma torch holder assembly
128	EX-0-706-063	Plastic housing edge cover

## Exploded view C

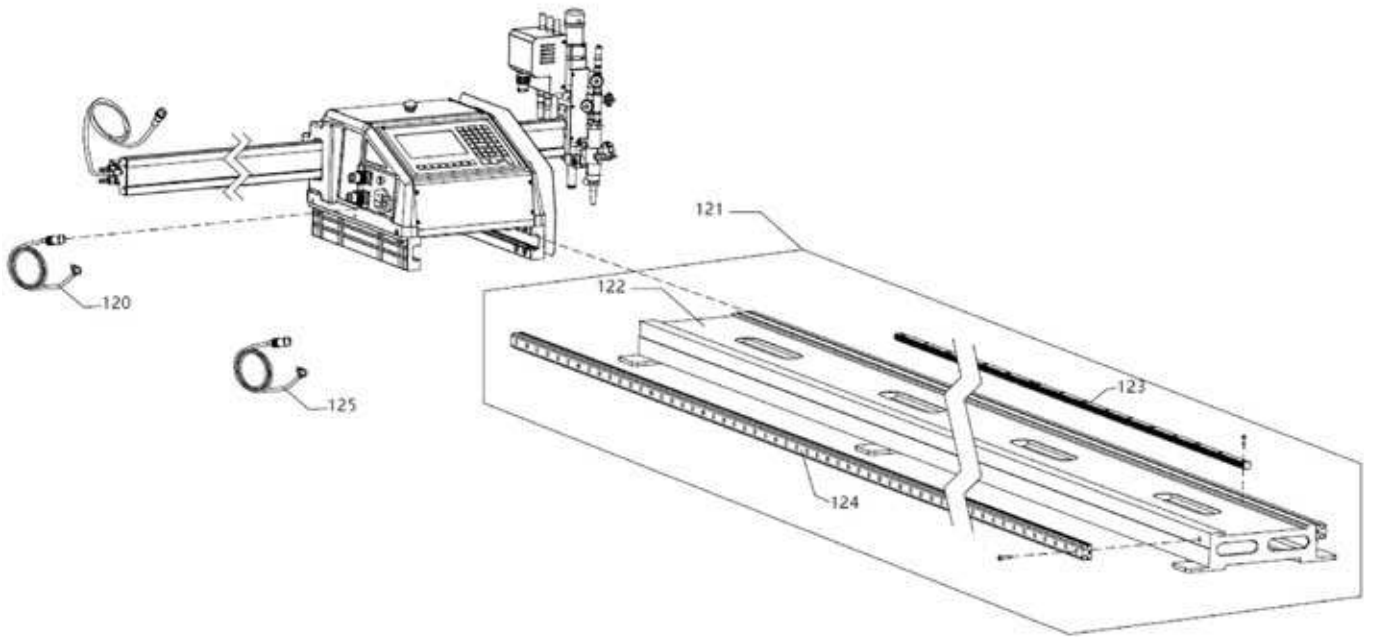

## Parts description C

Item	Part No.	DESCRIPTION
120	EX-0-706-105	Input power cord
121	EX-0-706-106	Rail assembly
122	EX-0-706-107	Longitudinal guide console
123	EX-0-706-108	20X2 Gear Rack (M1.273)
124	EX-0-706-109	Double-shaft rail (Ø12)
125	EX-0-803-004	CNC Interface connection lead 6m





## Revision history:

**1. Revision Nr: 01.1 - 06/2019** Official release

**2. Revision Nr: 01.2 - 10/2019** Page 24 - changed texts in table:

- a) Supply voltage - from: AC220V - 50HZ to: **AC110V/230V - 50HZ**
- b) Cutting speed (mm/min) - from: 50-2000 to: **50-3000**

**3. Revision Nr: 01.3 - 11/2019**

**4. Revision Nr: 01.4 - 03/2020** Added section 13 - Disposal page added.

**5. Revision Nr: 01.5 - 10/2020**

- a) Foreword changed from: or a plasma system can be added to: **optionally a plasma system can be added .**
- b) In complete manual changed axe name from: Z axe to: **S axe**
- c) Changed section 1.1.3. - updated point 3 ad point 5
- d) Changed section 1.2.4. - behind BLUE oxygen hoses added: (Green - in North America)
- e) Changed section 1.2.6. - updated point 7
- f) Changed section 2 - Location of warning and safety labels - table deleted
- g) Changed section 3.2. - added: Oscilloscope used for stepper motor test.
- h) Changed section 3.5. - added: This section involves measurement of open circuit voltages and therefore must be performed by a trained, qualified or certified electrical technician.
- i) Changed section 4 - new Block diagram picture

**6. Revision Nr: 02.0 - 12/2020** - New firmware: 3.0.4.-1.2.9 valid from S/N 1220-0001. All screens in manual changed.

**7. Revision Nr: 02.1 - 02/2021**

- a) page 76 - added - Converting table between seconds and millimeters you can find on page 98.
- b) page 98 - New section 10.6.2. Converting table for "Position Up Time" parameter

**8. Revision Nr: 02.2 - 08/2021**

- a) Section 9.5.6. Edge start cutting - page 64 - changed texts from: PIERCE HERE / MOVE PIERCE POSITION / NO PIERCE to new: HOLE HERE / MOVE HOLE POSITION / NO HOLE
- b) FW version 1.3.2. - added Ukrainian language to firmware

**9. Revision Nr: 02.3 - 12/2021**

- a) Added section: Enclosure 2: EX-TRACK®CNC Accessories (page 121)
- b) Added section: Enclosure 3: Exploded views (page 122-127)

**10. Revision Nr: 02.4 - 03/2022**

- a) Page 24 - added CE and CSA Name plate
- b) Page 30 - added „GREEN in North America„ to BLUE (2x)
- c) Page 33 - text in section 5.1.1. changed for new. Old was: The CNC unit is pre-adjusted from the production on 230VAC. If you need input voltage 110VAC, open the CNC unit and switch the switching power supply to your desire input voltage.
- d) Page 44 - changed scheme for new
- e) Page 46 - added new graphic - CE and CSA panels
- f) Page 98 - added new graphic - CE and CSA panels
- g) Page 100 - added CSE mark with text
- h) Page 126 - item 93 renamed from Oxygen hose to Oxygen „BLUE“ hose

**11. Revision Nr: 02.5 - 06/2022**

- a) Word changes through the manual

## ADDRESSES AND CONTACTS:

THERMACUT, K.S.

### HEADQUARTERS AND PRODUCTION:

THERMACUT, k.s.

Sokolovská 574, Mařatice

686 01 Uherské Hradiště

CZECH REPUBLIC

Tel.: +420 572 420 411

Fax: +420 572 420 420

E-mail: info@thermacut.cz

reditelstvi@thermacut.cz

www.thermacut.cz

### SALES DEPARTMENT:

Dukelská 76a,

742 42 Šenov u Nového Jičína

CZECH REPUBLIC

Tel.: +420 556 423 418, 440

Fax: +420 556 423 443, 444

E-mail: sales@thermacut.cz

obchod@thermacut.cz

www.thermacut.cz

### THERMACUT GMBH

Essener Str. 1

D-57234 Wilnsdorf

GERMANY

Tel.: +49 2739-4033-0

Fax: +49 2739 4033 77

E-mail: info@thermacut.de

www.thermacut.de

## SUBSIDIARIES:

### THERMACUT CROATIA D.O.O.

Daničićeva 12

532 70 Senj

CROATIA

Tel.: +385 53 882 599

Fax: +385 53 882 622

E-mail: thermacut@gs.t-com.hr

### THERMACUT HUNGÁRIA KFT.

Petőfi Sándor utca 37 atd.

2500 Esztergom

HUNGARY

Tel.: +36 33 502 090,1

Fax: +36 33 400 004

E-mail: info@thermacut.hu

www.thermacut.hu

### THERMACUT SLOVAKIA, S.R.O.

Priemyselná ulica 1239

931 01 Šamorín

SLOVAKIA

Tel.: +421 31 591 01 21-23

E-mail: obchod@thermacut.sk

www.thermacut.sk

### THERMACUT INC., USA

153 Charlestown Road

Claremont, NH 03743

E-mail: sales@thermacut.com

Tel.: +1 (800) 932-8312 / +1 (603) 543-0585

Fax: +1 (800) 972-6255 / +1 (603) 542-2867

www.thermacut.com

### THERMACUT-POLAND SP. Z O.O.

Aleja Jana Łyska 3

43-400 Cieszyn

POLAND

Tel.: +48 33 852 39 71

Tel./Fax: +48 33 852 13 34

E-mail: thermacut@pro.onet.pl

www.thermacut.pl

### THERMACUT ROMANIA SRL

B-dul 1 Decembrie 1918 nr. 127A

540445 Tg. Mures, Jud. Mures

ROMANIA

Tel.: +40 265 269 520, 263 205

Fax: +40 265 250 317

E-mail: office@thermacut.ro

www.thermacut.ro

### ALEXANDER BINZEL (UK) LTD./

### THERMACUT UK

Mill Lane, Winwick Quay

Warrington, Cheshire, WA2 8UA

Tel: +44(0) 1925 653944

Fax: +44(0) 1925 654861

Email: info@abimail.co.uk

www.binzel-abicor.co.uk

Distributor details:

**THERMACUT®**  
THE CUTTING COMPANY®

**THERMACUT, k. s.**  
**Sokolovská 574, Mařatice**  
**686 01, Uherské Hradiště**  
**Czech Republic**  
**[www.thermacut.cz](http://www.thermacut.cz)**  
**[sales@thermacut.cz](mailto:sales@thermacut.cz)**

**THERMACUT®, FHT-EX® and EX-TRAFIRE® are registered trademarks of THERMACUT, k.s.**  
**and may be registered in Czech Republic and/or other countries.**  
**All other trademarks are properties of their respective owners.**